

Hybrid Multi-Mode Microplate Reader

Synergy™ H1

Operator's Manual



Synergy H1

Multi-Mode Reader

Operator's Manual

BioTek® Instruments, Inc.

Part Number 8041000

Revision K

May 2016

© 2016

Notices

BioTek® Instruments, Inc.

Highland Park, P.O. Box 998

Winooski, Vermont 05404-0998 USA

All Rights Reserved

© 2016, BioTek® Instruments, Incorporated. No part of this publication may be reproduced, transcribed, or transmitted in any form, or by any means electronic or mechanical, including photocopying and recording, for any purpose other than the purchaser's use without written permission of BioTek Instruments, Inc.

Trademarks

BioTek® is a registered trademark and Synergy™, Gen5™, BioStack™, BioCell™, and Take3™ are trademarks of BioTek Instruments, Inc. Harta™ is a trademark of Harta Instruments.

Microsoft®, Windows®, Windows 7, Windows 8, and Excel® are either registered trademarks or trademarks of Microsoft Corporation in the United States and/or other countries.

All other trademarks are the property of their respective holders.

Restrictions and Liabilities

Information in this document is subject to change and does not represent a commitment by BioTek Instruments, Inc. Changes made to the information in this document will be incorporated in new editions of the publication. No responsibility is assumed by BioTek for the use or reliability of software or equipment that is not supplied by BioTek or its affiliated dealers.

Contents

Notices	ii
Trademarks	ii
Restrictions and Liabilities	ii
Contents	iii
Contact Information	x
Global Service and Support	x
Customer Service and Sales	x
Service/Technical Assistance Center (TAC)	x
European Coordination Center/Authorized European Representative	x
Revision History	xi
Document Conventions	xiv
Intended Use Statement	xiv
Quality Control	xv
Warranty and Product Registration	xv
Repackaging and Shipping	xv
Warnings	xvi
Hazards	xvi
Precautions	xvii
CE Mark	xix
Directive 2014/30/EU: Electromagnetic Compatibility	xix
Emissions—Class A	xix
Immunity	xix
Directive 2014/35/EU Low Voltage (Safety)	xix
Directive 2012/19/EU: Waste Electrical and Electronic Equipment	xx
Directive 98/79/EC: In Vitro Diagnostics (if labeled for this use)	xx
Electromagnetic Interference and Susceptibility	xx
USA FCC CLASS A	xx
Canadian Department of Communications Class A	xx
User Safety	xxi
Safety Symbols	xxii
Introduction	1
Product Description	2
Package Contents & Accessories	3
Optional Accessories	4
Materials for Conducting Liquid Tests	5

Product Support & Service	6
Technical Assistance Center (TAC)	6
Applications Support	6
Installation	7
Product Registration	8
Important Information	8
1: Unpack and Inspect the Synergy H1	9
2: Select an Appropriate Location	9
3: Remove the Shipping Hardware	10
4: Install the Power Supply	11
5: Install the Gas Controller	11
6: Unpack and Inspect the Dispense Module	12
7: Install the Dispense Module	13
8: Connect the Host Computer	16
9: Install Gen5 Software	17
10: Turn on the Reader	17
11: Establish Communication	17
12: Verify/Set Dispenser Calibration Values	18
13: Run a System Test	19
14: Test the Injection System	20
Operational/Performance Qualification	21
Repackaging and Shipping Instructions	22
Prepare the Dispense Module for Shipment	25
Getting Started	29
Modular Design	30
External Components	31
Internal Components	31
Filter Cube	32
Injection System	33
Dispense Module	33
Priming the Injection System	34
Gen5 Software	35
Define the Filter Cube in Gen5 and on the Reader	35
Protocols and Experiments	36
Dispense Module Control	37
Prime	37
Purge	37
Plate Shaking Options	38

Recommendations for Optimum Performance	39
General	39
Luminescence Measurements	40
Monochromator-Based Fluorescence Systems	40
Models with Injectors	40
Incubation and Partial Plates	40
Kinetic Assays Using the Continuous Shake Feature	41
Filters and Mirrors	43
Filter Cube Overview	44
Removing a Filter Cube	46
Installing a Filter Cube	46
Configuring the System for Luminescence Measurements	47
About the Gen5 Optics Library	47
Adding a Filter Cube to the Gen5 Optics Library	47
Handling Filters and Mirrors	49
Change a Filter or Mirror	49
Clean the Filters and Mirrors	52
Filters and Mirrors Available from BioTek	52
Preventive Maintenance	53
Overview	54
Daily Cleaning for the Dispense Module	54
Recommended Maintenance Schedule	55
Warnings and Precautions	56
Clean Exposed Surfaces	57
Inspect/Clean Excitation and Emission Filters	58
Inspect/Clean Mirrors	59
Materials	59
Procedure	60
Flush/Purge Fluid Path	61
Run a Dispense Protocol (Optional)	62
Empty/Clean the Tip Priming Trough	63
Clean the Priming Plate	63
Clean the Dispense Tubes and Injectors	63
Required Materials	63
Remove the Dispense Tubes and Injector Tip Holder	64
Clean the Dispense Tubes and Injectors	64
As-Needed Maintenance	65
Decontamination	66

Required Materials	66
Procedure for Models without the Dispense Module	67
Procedure for Models with the Dispense Module	68
Routine Procedure	68
Clean Exposed Surfaces	68
Decontaminate the Fluid Lines	69
Rinse the Fluid Lines	69
Clean the Tubing and Injectors	70
Decontaminate the Tip Priming Trough and Priming Plate	70
Alternate Procedure	70
Dispense Module, Syringe Replacement	71
Syringe Maintenance Position	71
Replace the Syringe	72
Instrument Qualification Process	73
Instrument System Test	74
Plate Shaker Test	74
Absorbance Testing	75
BioTek Absorbance Test Plates	75
Test Methods	75
Sample Test Report	76
Troubleshooting	76
Peak Absorbance Test	76
Alignment Test	77
Accuracy Test	77
Repeatability Test	77
Absorbance Liquid Tests	77
Test Methods	77
Gen5 Protocol Parameters	78
Results Analysis	80
Absorbance Liquid Test 1	80
Absorbance Liquid Test 2	80
Absorbance Liquid Test 3	81
Troubleshooting	82
Luminescence Testing	83
Test Method	83
Gen5 Protocol Parameters	83
Results Analysis	85
Pass/Fail Criteria	86

Troubleshooting	86
Fluorescence Testing	87
BioTek Fluorescence Test Plate	87
Results Analysis	87
Fluorescence Liquid Tests	88
Test Methods	88
Gen5 Protocol Parameters	88
Results Analysis	98
Corners Test	98
Sensitivity Test	98
Linearity Test	99
Fluorescence Polarization (FP) Test	99
Time-Resolved Fluorescence (TRF) Test	100
Troubleshooting	101
Injection System Testing	102
Test Method	102
Gen5 Parameters	102
Results Analysis	105
Instrument Qualification Procedures	107
Overview	108
IQ/OQ/PQ Description	109
Recommended Qualification Schedule	110
System Test	111
Setup	111
Test Procedure	111
Absorbance Plate Tests	112
Requirements	112
Setup	112
Test Procedure	113
Absorbance Liquid Tests	114
Absorbance Liquid Test 1	114
Materials	114
Solution A	114
Solution B	115
Test Procedure	115
Absorbance Liquid Test 2	116
Materials	116
Test Procedure	116

Absorbance Liquid Test 3	117
Materials	117
Buffer Solution	117
Test Procedure	118
Luminescence Test	119
Requirements	119
Test Procedure	119
Fluorescence Plate Tests	120
Requirements	120
Test Procedure	120
Fluorescence Liquid Tests	121
Materials	121
All tests:	121
Corners/Sensitivity/Linearity (FI) Tests:	123
Fluorescence Polarization (FP) Test:	123
Time-Resolved Fluorescence (TRF) Test:	124
Test Solutions	124
Corners/Sensitivity/Linearity (FI) Tests:	124
Fluorescence Polarization (FP) Test:	125
Time-Resolved Fluorescence (TRF) Test:	125
Test Procedure	126
Pipette Maps	127
Corners, Sensitivity, and Linearity (FI) Tests:	127
Fluorescence Polarization (FP) Test:	128
Time-Resolved Fluorescence (TRF) Test:	129
Alternate/Supplemental Tests Using Methylumbelliferone (MUB)	130
Materials	130
Test Solutions	131
Test Procedure	132
Pipette Map	133
Injection System Tests	134
Materials	134
Alternate Test Solutions	135
Test Procedure for Models with Absorbance Capability	135
Test Procedure for Models without Absorbance Capability	137
Specifications	139
General Specifications	140
Microplates	140

Hardware and Environmental	140
Absorbance Specifications	141
Optics	141
Performance	141
Accuracy	141
Linearity	141
Repeatability	142
Fluorescence Specifications	142
Monochromator-Based Fluorescence	142
Performance	142
Filter-Based Fluorescence	143
Fluorescence Intensity	143
Time-Resolved Fluorescence	143
Fluorescence Polarization	143
Luminescence Specifications	143
Dispense/Read Specifications	144
Error Codes	145
Overview	146
Error Codes	147
Instrument Dimensions for Robotic Interface	151
Sample Reports	155

Contact Information

BioTek® Instruments, Inc.
Highland Park, P.O. Box 998
Winooski, Vermont 05404-0998 USA

Global Service and Support

BioTek product service and repair is available worldwide at one of BioTek's International Service Centers and in the field at your location. To arrange for service or repair, contact the office nearest you; visit www.biotek.com for up-to-date contact information. For customer service, sales, and technical assistance, refer to the information below.

Customer Service and Sales

Internet: www.biotek.com

Phone: 888-451-5171 (toll-free in the U.S.) or 802-655-4740 (outside the U.S.)

Fax: 802-655-7941

Email: customercare@biotek.com

Service/Technical Assistance Center (TAC)

Phone: 800-242-4685 (toll free in the U.S.) or 802-655-4740 (outside the U.S.)

Fax: 802-654-0638

E-Mail: tac@biotek.com

European Coordination Center/Authorized European Representative

BioTek® Instruments GmbH
Kocherwaldstrasse 34
D-74177 Bad Friedrichshall
Germany

Internet: www.biotek.de

Phone: +49 (0) 7136 9680

Fax: +49 (0) 7136 968 111

E-Mail: info@biotek.de

Revision History

Rev	Date	Changes
A	11/2010	First issue
B	8/2011	<p>General: Updated instructions for new Gen5 version 2.x. Updated Absorbance Plate Test information. Preface: Updated Intended Use Statement.</p> <p>Chapter 1: Introduction: Updated Package Contents to remove wrench, plugs, clip, and storage bag; added screwdriver. Added Take3Trio Micro-Volume plate to list of supported plates and Optional Accessories. Updated Solutions for Liquid Tests in Optional Accessories.</p> <p>Chapter 4: Filter and Mirrors: Figure 2, corrected the caption by reversing the "EM" and "EX" filter designations.</p> <p>Chapter 7: Instrument Qualification: Updated Absorbance Plate Test definition instructions to support the Erbium glass filter in location C6. Updated Fluorescence Liquid Test information to include pre-configured TRF filter cube.</p> <p>Appendix A: Specifications: Corrected Incubation specification.</p>
C	11/2011	<p>Chapter 2: Installation: Updated the Carrier Shipping Bracket photo in Figure 1. Updated the BioTek part number for the shipping hardware. Updated the Dispense Module installation instructions.</p> <p>Chapter 7: Instrument Qualification: For the Absorbance Plate Test, removed the restriction on the use of the peak closest to 243 nm for the Erbium glass (any peak may be used). In the Fluorescence Liquid Tests section, for the Corners/Sensitivity/Linearity tests, added information on Sodium Fluorescein Kit, BioTek PN 7160013.</p> <p>Chapter 9: Specifications: Clarified the test methods used for Absorbance performance and incubation temperature.</p>
D	5/2012	<p>Preface: Updated the Intended Use Statement and the heading for the In Vitro Diagnostics directive to refer to the instrument's IVD label (if one exists). Added 'Service' and 'Accessories' hazard warnings. Added 'Spare Parts' precaution. Added warning to have two people lift and carry the instrument.</p> <p>Chapter 1, Introduction: Corrected the power supply part number. Added support for the gas controller.</p> <p>Chapter 3, Getting Started: Added gas controller modules. Updated the chemical compatibility table for the dispense module.</p> <p>Appendix B, Error Codes: Added new information to the "Description and Possible Remedy" sections for several codes.</p>
E	9/2012	Preface: Added EN 61010-2-010 to Directive 2006/95/EC.

Rev	Date	Changes
		<p>Section 1, Introduction: Added information on patent for dual light path capability.</p> <p>Appendix A, Specifications: Updated flash lamp specifications.</p>
F	10/2013	<p>Preface: Updated contact information to include global information.</p> <p>Chapter 1, Introduction: Added information about the incubation gradient.</p> <p>Chapter 3, Getting Started: Added the workarounds for kinetic assays with continuous shake.</p> <p>Chapter 4, Filters and Mirrors: Added a note that the polarizer filters are keyed to fit in the correct alignment in the filter cube.</p> <p>Chapter 7, Instrument Qualification: Added "filter-based" to TRF descriptions.</p> <p>Appendix A, Specifications: Added information about the incubation gradient.</p>
G	3/2014	<p>Chapter 4, Filters and Mirrors: Add photos to procedure for installing the filter cube; added a table of mirrors with their wavelength ranges.</p>
H	10/2014	<p>General: Updated references to USB drivers to state that they now reside on the Gen5 software media. Removed statements that the serial numbers must match between the reader and dispense module. Changed 'RMA' to 'service authorization number'.</p> <p>Chapter 2, Installation: Added a new step 13 to verify/set dispenser calibration values.</p> <p>Chapter 3, Getting Started: Added a note stating that the workarounds for kinetic assays with continuous shake apply to Synergy H1 basecode software versions lower than 2.00 (the issue was addressed in v2.00).</p> <p>Chapter 7, Instrument Qualification: Corrected the PN for the pre-configured qualification TRF filter cube (8040555). Under 'Harta Plate Test': updated instructions for checking the test plate's battery; changed the location of the buffer wells in the [filter-based] plate layout (from E1-H4 to D1-G4) and added a note regarding these wells for the monochromator-based test (F1-G12); updated the attomole conversion and battery check formulas. Under 'Glowell Test', revised the radiant flux correction formula.</p>
I	4/2015	<p>Preface, Contact Information: To reduce the risk of providing outdated contact information for BioTek's offices worldwide, replaced the former detailed information for every location with a simpler instruction to visit www.biotek.com for the most up-to-date information. CE Mark: Updated Directive headings. Notices: Remove trademark information for Kalrez and Glowell.</p> <p>Chapter 3, Getting Started: To 'Recommendations for Optimum Performance' added information on the use of acids, corrosives, and solvents.</p> <p>Chapter 7, Instrument Qualification, Luminescence Test: Removed the Glowell Test procedure. In the Gen5 [Harta] protocol parameters tables, changed the Dynamic Range for the Battery Check read steps to Extended.</p>

Rev	Date	Changes
J	10/2015	<p><i>Preface</i>, CE Mark section: Updated Directive headings.</p> <p>Chapter 2, <i>Installation</i>, removed former step 3 "Unpack and Inspect the Gas Controller" (the user is now referred to the <i>Gas Controller User Guide</i>).</p> <p>Chapter 3, <i>Getting Started</i>, clarified that most models ship with a filter cube installed, and the reader's internal software is configured for that cube. If the cube is modified or replaced, the software must be updated accordingly. In the Gen5 Software section, enhanced instructions for updating the Gen5 Filter Cube table. Added information on the reader's plate shaking capabilities.</p> <p>Created a new Chapter 7, <i>Instrument Qualification Process</i> to describe the tests designed to qualify the Synergy H1. Added Gen5 protocol parameters tables for Absorbance Testing. Renamed the former Chapter 7, <i>Instrument Qualification</i> as Chapter 8, <i>Instrument Qualification Procedures</i> and moved the description content to the aforementioned new chapter.</p> <p>For the Injection System Tests, corrected the volume of water that is manually pipetted on top of the green test dye solution just prior to the plate read (changed from 200 μL/well to 150 μL).</p> <p>Added information for purchasing and using the BioTek 340 nm Absorbance Test Plate (BTI #7260551).</p>
K	5/2016	<p>Added information on using the BioTek Fluorescence Test Plate to qualify the Synergy H1 fluorescence system. Updated the Fluorescence Intensity and TRF liquid tests to utilize a single concentration well and median buffer well when determining the detection limit.</p>

Document Conventions

	This icon identifies information that protects the safety of the operator and the integrity of data.
Warning!	A Warning indicates the potential for bodily harm and tells you how to avoid the problem.
Caution	A Caution indicates the potential for damage to the instrument and tells you how to avoid the problem.

Note:	Bold text is primarily used for emphasis.
	This icon calls attention to important information.

This style calls attention to usage instructions and helpful facts. For example, "Refer to [Figure 2-3](#) when performing these steps" and "Part numbers are subject to change."

Topics that apply only to specific reader models are presented in this style. For example, "Applies only to models equipped with injectors."

Intended Use Statement

- The Synergy H1 is a hybrid multi-mode microplate reader. The performance characteristics of the data reduction software have not been established with any laboratory diagnostic assay. The user must evaluate this instrument and PC-based software in conjunction with their specific assay(s). This evaluation must include the confirmation that performance characteristics for the specific assay(s) are met.
- If the instrument has an "IVD" label it may be used for clinical and nonclinical purposes, including research and development. If there is no such label the instrument may be used only for research and development or other nonclinical purposes.

Quality Control

It is considered good laboratory practice to run laboratory samples according to instructions and specific recommendations included in the assay package insert for the test to be conducted. Failure to conduct Quality Control checks could result in erroneous test data.

Warranty and Product Registration

Take a moment to review the Warranty information that shipped with your product. Please also register your product with BioTek to ensure that you receive important information and updates about the product(s) you have purchased. Register online through the Customer Resource Center at www.biotek.com or call (888) 451-5171 or (802) 655-4740.

Repackaging and Shipping



If you need to ship the instrument to BioTek for service or repair, contact BioTek for a Service Call Notice (SCN) number, and be sure to use the original packing materials. Other forms of commercially available packaging are not recommended and can void the warranty. If the original packing materials have been damaged or lost, contact BioTek for replacement packing.

Warnings



Operate the instrument on a level, stable surface away from excessive humidity.

Bright sunlight or strong incandescent light can reduce the linear performance range of the instrument.

Measurement values may be affected by extraneous particles (such as dust) in the microplate wells. A clean work area is necessary to ensure accurate readings.

When operated in a safe environment according to the instructions in this document, there are no known hazards associated with the instrument. However, the operator should be aware of certain situations that could result in serious injury; these vary depending on the instrument type. See [Hazards](#) and [Precautions](#).

Hazards

The following hazard warnings are provided to help avoid injury:





Warning! Power Rating. The instrument's power supply or power cord must be connected to a power receptacle that provides voltage and current within the specified rating for the system. Use of an incompatible power receptacle may produce electrical shock and fire hazards.

Warning! Electrical Grounding. Never use a plug adapter to connect primary power to the external power supply. Use of an adapter disconnects the utility ground, creating a severe shock hazard. Always connect the power cord directly to an appropriate receptacle with a functional ground.

Warning! Service. Only qualified technical personnel should perform service procedures on internal components.

Warning! Accessories. Only accessories that meet the manufacturer's specifications shall be used with the instrument.

Warning! The instrument with all available modules weighs up to 55 pounds (24.95 kg). Use two people when lifting and carrying the instrument.

	<p>Warning! Liquids. Avoid spilling liquids on the instrument; fluid seepage into internal components creates a potential for shock hazard or instrument damage. If a spill occurs while a program is running, abort the program and turn the instrument off. Wipe up all spills immediately. Do not operate the instrument if internal components have been exposed to fluid; contact BioTek TAC.</p> <p>Warning! Unspecified Use. Failure to operate the equipment according to the guidelines and safeguards specified in this manual could result in a hazardous condition.</p> <p>Warning! Software Quality Control. The operator must follow the manufacturer's assay package insert when modifying software parameters and establishing reading or dispensing methods. Failure to conduct quality control checks could result in erroneous test data.</p> <p>Warning! Reader Data Reduction Protocol. No limits are applied to the raw measurement data. All information exported via computer control must be thoroughly analyzed by the operator.</p>
	<p>Warning! Internal Voltage. Always turn off the power switch and unplug the power supply before cleaning the outer surface of the instrument.</p>
	<p>Warning! Potential Biohazards. Some assays or specimens may pose a biohazard. This hazard is noted by the symbol shown here. Adequate safety precautions should be taken as outlined in the assay's package insert. Always wear safety glasses and appropriate protective equipment, such as chemically resistant rubber gloves and apron.</p>
	<p>Warning! Pinch Hazard. Some areas of the dispense module can present pinch hazards when the instrument is operating. The module is marked with the symbol shown here. Keep hands and fingers clear of these areas when the instrument is operating.</p>

Precautions

The following precautions are provided to help avoid damage to the instrument.

	<p>Caution: Service. The instrument should be serviced by BioTek-authorized personnel. Only qualified technical personnel should perform troubleshooting and service procedures on internal components.</p> <p>Caution: Spare Parts. Only approved spare parts should be used for maintenance. The use of unapproved spare parts and accessories may result in a loss of warranty and potentially impair instrument performance or cause damage to the instrument.</p>
---	--

Caution: Environmental Conditions. Do not expose the instrument to temperature extremes. For proper operation, ambient temperatures should remain within the range listed in the **Specifications** chapter. Performance may be adversely affected if temperatures fluctuate above or below this range. Storage temperature limits are broader.

Caution: Sodium Hypochlorite. Do not expose any part of the instrument to the recommended diluted sodium hypochlorite solution (bleach) for more than 20 minutes. Prolonged contact may damage the instrument surfaces. Be certain to rinse and thoroughly wipe all surfaces.

Caution: Power Supply. Use only the power supply shipped with the instrument, and operate it within the range of line voltages listed on it.

Caution: Disposal. Dispose of the instrument according to Directive 2012/19/EU, "on waste electrical and electronic equipment (WEEE)," or local ordinances.

Caution: Warranty. Failure to follow preventive maintenance procedures may **void the warranty**.

Caution: Shipping Hardware. All shipping hardware (e.g., carrier shipping screw, filter reader shipping bracket) must be removed before operating the instrument and reinstalled before repackaging the instrument for shipment.

Caution: Electromagnetic Environment. Per EN 61326-2-6 it is the user's responsibility to ensure that a compatible electromagnetic environment for this instrument is provided and maintained in order that the device will perform as intended.

Caution: Electromagnetic Compatibility. Do not use this device in close proximity to sources of strong electromagnetic radiation (e.g., unshielded intentional RF sources), because these may interfere with the proper operation.

CE Mark



See the Declaration of Conformity for more specific information.

Directive 2014/30/EU: Electromagnetic Compatibility

Emissions—Class A

The system has been type-tested by an independent, accredited testing laboratory and found to meet the requirements of EN 61326-1: Class A for Radiated Emissions and Line Conducted Emissions.

Verification of compliance was conducted to the limits and methods of EN 55011 – (CISPR 11) Class A. In a domestic environment it may cause radio interference, in which case, you may need to take measures to mitigate the interference.

Immunity

The system has been type-tested by an independent, accredited testing laboratory and found to meet the requirements of EN 61326-1 and EN 61326-2-6 for Immunity.

Verification of compliance was conducted to the limits and methods of the following:

EN 61000-4-2, Electrostatic Discharge

EN 61000-4-3, Radiated EM Fields

EN 61000-4-4, Electrical Fast Transient/Burst

EN 61000-4-5, Surge Immunity

EN 61000-4-6, Conducted Disturbances from RFI

EN 61000-4-11, Voltage Dips, Short Interruptions and Variations

Directive 2014/35/EU Low Voltage (Safety)

The system has been type-tested by an independent testing laboratory and was found to meet the requirements of this Directive. Verification of compliance was conducted to the limits and methods of the following:

EN 61010-1, "Safety requirement for electrical equipment for measurement, control and laboratory use. Part 1, General requirements."

EN 61010-2-081, "Particular requirements for automatic and semi-automatic laboratory equipment for analysis and other purposes."

EN 61010-2-010, "Particular requirements for laboratory equipment for the heating of materials."

Directive 2012/19/EU: Waste Electrical and Electronic Equipment

Disposal Notice: Dispose of the instrument according to the Directive, “on waste electrical and electronic equipment (WEEE)” or local ordinances.

Directive 98/79/EC: In Vitro Diagnostics (if labeled for this use)

Product registration with competent authorities.

Traceability to the U.S. National Institute of Standards and Technology (NIST).

EN 61010-2-101, “Particular requirements for in vitro diagnostic (IVD) medical equipment.”

Electromagnetic Interference and Susceptibility

USA FCC CLASS A

RADIO AND TELEVISION INTERFERENCE

NOTE: This equipment has been tested and found to comply with the limits for a Class A digital device, pursuant to Part 15 of the FCC Rules. These limits are designed to provide reasonable protection against harmful interference when the equipment is operated in a commercial environment. This equipment generates, uses, and can radiate radio frequency energy and, if not installed and used in accordance with the instruction manual, may cause harmful interference to radio communications. Operation of this equipment in a residential area is likely to cause harmful interference, in which case the user will be required to correct the interference at their own expense.

In order to maintain compliance with FCC regulations shielded cables must be used with this equipment. Operation with non-approved equipment or unshielded cables is likely to result in interference to radio and television reception.

Canadian Department of Communications Class A

This digital apparatus does not exceed Class A limits for radio emissions from digital apparatus set out in the Radio Interference Regulations of the Canadian Department of Communications.

Le présent appareil numérique n'émet pas de bruits radioélectriques dépassant les limites applicables aux appareils numérique de la Class A prescrites dans le Règlement sur le brouillage radioélectrique édicté par le ministère des Communications du Canada.









User Safety









This device has been type-tested by an independent laboratory and found to meet the requirements of the following:

- Underwriters Laboratories UL 61010-1, "Safety requirements for electrical equipment for measurement, control and laboratory use; Part 1: General requirements."
- Canadian Standards Association CAN/CSA C22.2 No. 61010-1, "Safety requirements for electrical equipment for measurement, control and laboratory use; Part 1: General requirements."
- EN 61010 Standards, see [CE Mark](#) starting on page [xix](#).

Safety Symbols

Some of these symbols appear on the instrument or accessories.

 <p>Alternating current Courant alternatif Wechselstrom Corriente alterna Corrente alternata</p>	 <p>Both direct and alternating current Courant continu et courant alternatif Gleich - und Wechselstrom Corriente continua y corriente alterna Corrente continua e corrente alternata</p>
 <p>Direct current Courant continu Gleichstrom Corriente continua Corrente continua</p>	 <p>Earth ground terminal Borne de terre Erde (Betriebserde) Borne de tierra Terra (di funzionamento)</p>
 <p>On (Supply) Marche (alimentation) Ein (Verbindung mit dem Netz) Conectado Chiuso</p>	 <p>Protective conductor terminal Borne de terre de protection Schutzleiteranschluss Borne de tierra de protección Terra di protezione</p>
 <p>Off (Supply) Arrêt (alimentation) Aus (Trennung vom Netz) Desconectado Aperto (sconnessione dalla rete di alimentazione)</p>	 <p>Caution (refer to accompanying documents) Attention (voir documents d'accompagnement) Achtung siehe Begleitpapiere Atención (vease los documentos incluidos) Attenzione, consultare la doc annessa</p>

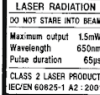
 <p>Warning, risk of electric shock Attention, risque de choc électrique Gefährliche elektrische schlag Precaución, riesgo de sacudida eléctrica Attenzione, rischio di scossa elettrica</p>	  <p>Warning, risk of crushing or pinching Attention, risque d'écrasement et pincement Warnen, Gefahr des Zerquetschens und Klemmen Precaución, riesgo del machacamiento y sejeción Attenzione, rischio di schiacciare ed intrappolarsi</p>
 <p>Warning, hot surface Attention, surface chaude Warnen, heiße Oberfläche Precaución, superficie caliente Attenzione, superficie calda</p>	 <p>Warning, potential biohazards Attention, risques biologiques potentiels Warnung! Moegliche biologische Giftstoffe Atención, riesgos biológicos Attenzione, rischio biologico</p>
 <p>In vitro diagnostic medical device Dispositif médical de diagnostic in vitro Medizinisches In-Vitro-Diagnostikum Dispositivo médico de diagnóstico in vitro Dispositivo medico diagnostico in vitro</p>	 <p>Separate collection for electrical and electronic equipment Les équipements électriques et électroniques font l'objet d'une collecte sélective Getrennte Sammlung von Elektro- und Elektronikgeräten Recogida selectiva de aparatos eléctricos y electrónicos Raccolta separata delle apparecchiature elettriche ed elettroniche</p>
 <p>Consult instructions for use Consulter la notice d'emploi Gebrauchsanweisung beachten Consultar las instrucciones de uso Consultare le istruzioni per uso</p>	  <p>Laser radiation: Do not stare into beam Rayonnement laser: Ne pas regarder dans le faisceau Laserstrahlung: Nicht in den strahl blicken Radiación de láser: No mire fijamente al rayo Radiazione di laser: Non stare nel fascio</p>

Introduction

This chapter introduces the Synergy H1 Multi-Mode Reader, describes its key features, lists its package contents, and provides contact information for technical assistance.

Product Description	2
Package Contents & Accessories	3
Optional Accessories	4
Materials for Conducting Liquid Tests	5
Product Support & Service	6
Technical Assistance Center (TAC)	6
Applications Support	6

Product Description

The Synergy H1 is a hybrid multi-mode microplate reader. Depending on the model, detection modes include fluorescence intensity (FI), fluorescence polarization (FP), time-resolved fluorescence (TRF), luminescence, and UV-visible absorbance. The instrument is modular, and upgrade options are available; contact BioTek Customer Care for more information.

The reader is computer-controlled using Gen5 software for all operations, including data reduction and analysis. The Synergy H1 is robot accessible and compatible with the BioStack Microplate Stacker. Gen5 supports OLE automation to facilitate integration into an automated system.

The Synergy H1 can perform reads using a filter cube or a monochromator*. The filter-based system can perform fluorescence and luminescence reads. Filter fluorescence uses a xenon flash light source, along with interference filters and dichroic mirrors for wavelength specificity and a photomultiplier tube (PMT) detector. To run a fluorescence polarization protocol, the filter cube must contain polarizing filters. Luminescence is measured through an empty filter position in the filter cube; filters can be used if light filtering is necessary.

The monochromator-based system, which has both top and bottom probes, is used for absorbance, fluorescence, and luminescence. Absorbance measurements are made using the reader's monochromator optics. The xenon lamp allows for both UV and visible light measurements. The monochromator provides wavelength selection from 230–999 nm in 1-nm increments. Available read methods are endpoint, area scan, spectral scanning, and pathlength correction. For luminescence reads, the Synergy H1 has a direct-to-PMT channel (no filtering, white light only). You can also use the monochromator optics for luminescence spectral scanning.

The Synergy H1 has top and bottom incubation from 4°C over ambient to 45°C, controlled via a software-adjustable gradient. Internal plate shaking, with both linear and orbital modes, is supported to ensure that reagents are thoroughly mixed prior to reading. The Synergy H1 supports the reading of 6-, 12-, 24-, 48-, 96-, and 384-well microplates with 128 x 86 mm geometry as well as the Take3 and Take3 Trio Micro-Volume Plate.

① Use of microplates other than those listed here can result in positioning errors during program execution.

Models with injectors support dual-reagent dispensing to 6-, 12-, 24-, 48-, 96-, and 384-well microplates. An external dispense module pumps fluid from the supply bottles to the two injectors located inside the instrument. Models that support the gas controller can control the CO₂ or O₂ concentrations in the reading chamber for CO₂- or O₂-sensitive assays.

* This dual light path capability in the H1 MF model is protected by U.S. patent number 8,218,141.

Package Contents & Accessories

Package contents and part numbers are subject to change. Please contact BioTek Customer Care with any questions.

Item	BTI Part #
<i>Synergy H1 Operator's Manual</i> (on USB flash drive)	8041000
Power supply	76061
Power cord set (specific to installation environment):	
Europe (Schuko)	75010
USA/International	75011
United Kingdom	75012
Australia/New Zealand	75013
USB cable	75108
Models with injectors ("D" models), an external dispense module with the following accessories:	
Injector assembly	8040541
Inlet tubes (2) from supply bottles to syringe drives	7082121
250- μ L syringes (2)	7083000
Syringe thumbscrews (2)	19511
Priming plate	8042202
Injector tip priming trough	8042068
Dispense module communication cable	75107
Dispense module front cover	8042197
Dispense module box	8040534
Supply bottles (2, 30 mL)	7122609
Supply bottle holders (2)	8042193
Straps to secure bottles in the holders (6)	7212035
Injector tip cleaning stylus and storage bag	2872304
Models with the gas controller ("G") module (packaged separately), one of the following:	
Gas controller unit, CO ₂ /O ₂ control, and shipping accessories	1210500, 1210010
Gas controller unit, CO ₂ control, and shipping accessories	1210504, 1210009

Optional Accessories

Availability and part numbers are subject to change. Please contact BioTek Customer Care with any questions, or visit our website and use the Accessories search tool.

Item	BTI Part #
Absorbance Test Plate (400-800 nm)	7260522
Absorbance Test Plate (340 nm)*	7260551
Luminometer Reference Microplate (includes microplate carrier adapter BTI #8042263 for Synergy H1)	8030015
Fluorescence Test Plate**	1400006
Take3 Micro-Volume Plate	TAKE3
Take3 Trio Micro-Volume Plate	TAKE3TRIO
PCR Tube Adapter Plates	6002072, 6002076
BioCell Adapter Plate	7270512
BioCell Quartz Vessel	7272051
Gas-ready upgrade kit	contact BioTek Sales
Synergy H1 Product Qualification and Maintenance (IQ/OQ/PQ) package	8040528
Additional filters and filter cubes; contact BioTek Customer Care for availability and part numbers	
The Synergy H1 is compatible with the BioStack Microplate Stacker. The BioStack rapidly and systematically transfers a stack of microplates to and from the instrument's microplate carrier. Contact BioTek or visit our website to learn more.	

* The diagnostics feature in Gen5 versions 2.08 and higher is compatible with the 340 nm Absorbance Test Plate BTI #7260551. If you are using an earlier Gen5 version, the test plate's instruction sheet explains how to manually conduct the tests and analyze results.

** Requires Gen5 version 2.06 or higher.

Materials for Conducting Liquid Tests

Manufacturer part numbers are subject to change.

Item	Part Number
Absorbance Liquid Tests	
BioTek Wetting Agent Solution	BTI #7773002
BioTek QC Check Solution #1 (25 mL)	BTI #7120779
BioTek QC Check Solution #1 (125 mL)	BTI #7120782
Phosphate-Buffered Saline (PBS) tablets, pH 7.2-7.6	Sigma #P4417
β -NADH Powder (β -Nicotinamide Adenine Dinucleotide, reduced form)	BTI #98233 or Sigma #N6785-10VL
Fluorescence Liquid Tests	
<i>Test Kits</i>	
Kit with microplates and test solutions for conducting Corners/Sensitivity/Linearity (FI) tests using Sodium Fluorescein and Methylumbelliferone, and Time-Resolved Fluorescence (TRF) tests using Europium	BTI #7160010 (contains 7160013, 7160012, and 7160011 described below)
Kit for FI tests using Sodium Fluorescein	BTI #7160013
Kit for FI tests using Methylumbelliferone	BTI #7160012
Kit for TRF tests using Europium	BTI #7160011
Kit for Fluorescence Polarization (FP) test	BTI #7160014 or Invitrogen #P3088
<i>Individual Materials</i>	
Sodium Fluorescein Powder, 1-mg vial	BTI #98155
Methylumbelliferone, 10-mg vial	BTI #98156
Carbonate-Bicarbonate Buffer (CBB) capsules	Sigma #3041
Phosphate-Buffered Saline (PBS) tablets, pH 7.2-7.6	Sigma #P4417
Sodium Borate, pH 9.18	Fisher Scientific #159532, or equivalent
Injection System Tests	
BioTek Green Test Dye	BTI #7773003

Product Support & Service

See also [Contact Information](#) on page x.

Technical Assistance Center (TAC)

If your BioTek product fails to function properly, if you have questions about how to use or maintain our products, or if you need to send an instrument to BioTek for repair or other service, please contact our Technical Assistance Center ("TAC"). TAC is open from 8:30 AM to 5:30 PM (EST), Monday through Friday, excluding standard U.S. holidays.

TAC@biotek.com

Phone: (800) 242-4685 or (802) 655-4740

Fax: (802) 654-0638

Please be ready with the following information:

- Your name and company, email address, daytime phone or fax number
- The product name, model, and serial number
- The onboard software part number and basecode version (available through Gen5 by selecting System > Instrument Control > Information)
- Gen5 software version information (Help > About Gen5)
- For troubleshooting assistance or instruments needing repair, the specific steps that led to the problem and any error codes that were reported (see also [Error Codes](#) starting on page 145)

If you need to send an instrument to BioTek, please contact the TAC for a Service Call Notice (SCN) number and the shipping address. Package the instrument according to the instructions in [Repackaging and Shipping Instructions](#) starting on page 22.

Applications Support

BioTek's fully equipped Application Laboratory provides our on-staff scientists with the means to assist you with the integration of our instrumentation and software with your unique scientific applications. If you are having difficulty with optimizing fluorescence sensitivity or integrating a unique data reduction transformation, or you are just looking for a recommendation on an appropriate fluorophore, contact us.

Applications@biotek.com or (888) 451-5171

Installation

This chapter includes instructions for unpacking and setting up the Synergy H1 and, as applicable, the gas controller and external dispense module. Instructions are also included for preparing the reader and dispense module for shipment.

Product Registration	8
Important Information	8
1: Unpack and Inspect the Synergy H1	9
2: Select an Appropriate Location	9
3: Remove the Shipping Hardware	10
4: Install the Power Supply	11
5: Install the Gas Controller	11
6: Unpack and Inspect the Dispense Module	12
7: Install the Dispense Module	13
8: Connect the Host Computer	16
9: Install Gen5 Software	17
10: Turn on the Reader	17
11: Establish Communication	17
12: Verify/Set Dispenser Calibration Values	18
13: Run a System Test	19
14: Test the Injection System	20
Operational/Performance Qualification	21
Repackaging and Shipping Instructions	22

Product Registration

Please register your products with BioTek to ensure that you receive important information and updates about the products you have purchased.

Register online through BioTek's Customer Resource Center (CRC) at www.biotek.com or by contacting BioTek Customer Care.

Important Information



This chapter contains installation and setup tasks for a Synergy H1 model equipped with all of the available modules. Your model may be different; for example, it may not have injection capability. Perform the tasks in the order presented, skipping those that do not apply to your reader's configuration.

Materials: You will need a Phillips screwdriver (supplied with the instrument) to perform some of the steps in this chapter.



Remove the shipping hardware before turning on the instrument.
Reinstall the shipping hardware before repackaging the instrument for shipment.

1: Unpack and Inspect the Synergy H1



The Synergy H1 with all available modules weighs up to 55 pounds (24.95 kg). Use two people when lifting and carrying the instrument.

Save all packaging materials. If you need to ship the reader to BioTek for repair or replacement, you must use the original materials. Using other forms of commercially available packaging, or failing to follow the repackaging instructions, may **void the warranty**. Improper packaging the results in damage to the reader may lead to additional charges.

During the unpacking process, inspect the packaging, reader, and accessories for shipping damage. If the reader is damaged, notify the carrier and your BioTek representative. Keep the shipping boxes and the packaging materials for the carrier's inspection. BioTek will arrange for repair or replacement of your reader immediately.

1. Open the shipping box. Remove the instrument and place it on a level, stable surface.
2. Place the packaging materials back into the shipping box for reuse if the instrument needs to be shipped again.

2: Select an Appropriate Location

Install the reader on a level, stable surface in an area where ambient temperatures between 18°C (64°F) and 40°C (104°F) can be maintained. Leave at least six inches of space between the instrument's rear panel and any other object. This space ensures proper air flow in and out of the instrument.

The reader is sensitive to extreme environmental conditions. Avoid the following:

- **Excessive humidity.** Condensation directly on the sensitive electronic circuits can cause the instrument to fail internal self-checks. The humidity must be in the range of 10–85%, non-condensing.
- **Excessive ambient light.** Bright light may affect the reader's optics and readings, reducing its linear range.
- **Dust.** Readings may be affected by extraneous particles (such as dust) in the microplate wells. A clean work area is necessary to ensure accurate readings.

If you will be installing the BioStack for operation with the Synergy H1, you may wish to seat the instruments in their aligning plates now. Refer to the *BioStack Operator's Manual* for more information.

3: Remove the Shipping Hardware



Remove all shipping hardware before turning on the reader.

1. Locate the shipping hardware, as shown in the photos below.
2. Pull down the microplate carrier access door. Using a screwdriver, remove the carrier shipping bracket.
3. If the instrument is equipped with the filter module: Open the top access door and use a screwdriver to remove the filter reader shipping bracket.
4. Store the shipping hardware with the original packaging for reuse in case you need to ship the instrument.

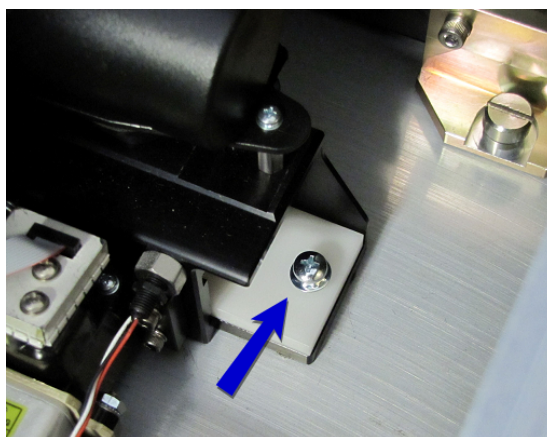
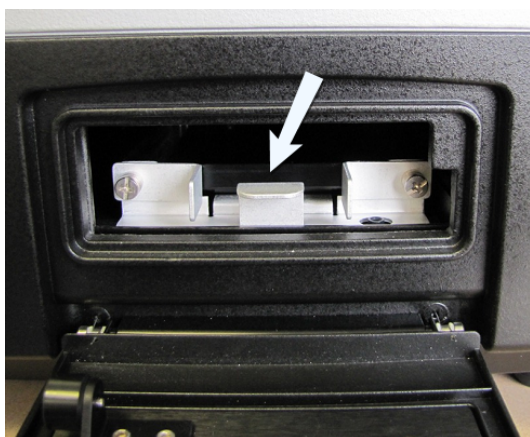

Figure 2-1: Carrier shipping bracket (left), and filter reader shipping bracket

4: Install the Power Supply



Power Rating. The instrument must be connected to a power receptacle that provides voltage and current within the specified rating for the system. Use of an incompatible power receptacle may produce electrical shock and fire hazards.

Electrical Grounding. Never use a plug adapter to connect primary power to the instrument. Use of an adapter disconnects the utility ground, creating a severe shock hazard. Always connect the system power cord directly to an appropriate receptacle with a functional ground.

1. Plug the power supply's cord into the power inlet on the rear of the reader.
2. Connect the power cord to the power supply.
3. Plug the power cord into an appropriate power receptacle.

5: Install the Gas Controller

Applies only to models compatible with the BioTek gas controller module

If you purchased a gas controller for use with the Synergy H1, you may wish to install it now. Refer to the *Gas Controller User Guide* for complete instructions.

6: Unpack and Inspect the Dispense Module

Applies only to models equipped with injectors



Save all packaging materials. If you need to ship the dispense module to BioTek for repair or replacement, you must use the original materials. Using other forms of commercially available packaging, or failing to follow the repackaging instructions, may **void your warranty**.

During the unpacking process, inspect the packaging, module, and accessories for shipping damage. If the dispense module is damaged, notify the carrier and your BioTek representative. Keep the shipping boxes and the packaging materials for the carrier's inspection. BioTek will arrange for repair or replacement of your dispense module immediately.

Refer to [Figure 2-9](#) and [Figure 2-10](#) starting on page 26.

1. Open the shipping box. Remove the accessories box and the foam insert that contains the injector tubing and bottle holders.
2. Lift out the module and place it on a level surface.
3. Open the accessories box and remove its contents. Refer to [Package Contents & Accessories](#) on page 3 for the expected items.
4. Place all packaging materials into the shipping box for reuse if the dispense module needs to be shipped.

7: Install the Dispense Module

Applies only to models equipped with injectors

1. Place the dispense module on top of the reader or, if equipped, on top of the gas controller module.

ⓘ Do not place the dispense module *next to* the reader.



Figure 2-2: Dispense module on top of the reader (shown without the gas controller)

2. Open the bag containing the injector tubes and tips. Remove the clear shrouds from the tubes.
3. Remove the two inlet tubes from their canisters.
4. Identify the two syringe valves on the dispense module (see [Figure 2-4](#) on page 15). Each is labeled with a left-pointing arrow.

ⓘ When installing the tubes, do not use any tools. Finger-tighten only!

5. Screw the fitting of one inlet tube into the right side of the Syringe 1 valve.
6. Screw one end of one outlet tube into the left side of the Syringe 1 valve.
7. Repeat these steps to attach the inlet and outlet tubing for Syringe 2.

	<p>It is critical that each tubing set is correctly connected from the syringe valve, through the light shield, to the injector tip holder. Otherwise, injected fluid may miss the intended well.</p>
---	--

8. Remove the tubing feed-through cover from the top of the reader (2 screws). Store the cover and screws with the shipping hardware in case the reader needs to be shipped again.
9. Thread the injector tip holder, with outlet tubing connected to both ports, through the hole in the top of the reader.
10. Open the reader's top access door, and, holding the injector tip holder by the tab, insert the injector tips into the appropriate holes inside the reader.

A magnet helps guide the tips into place and secures them in the reader.

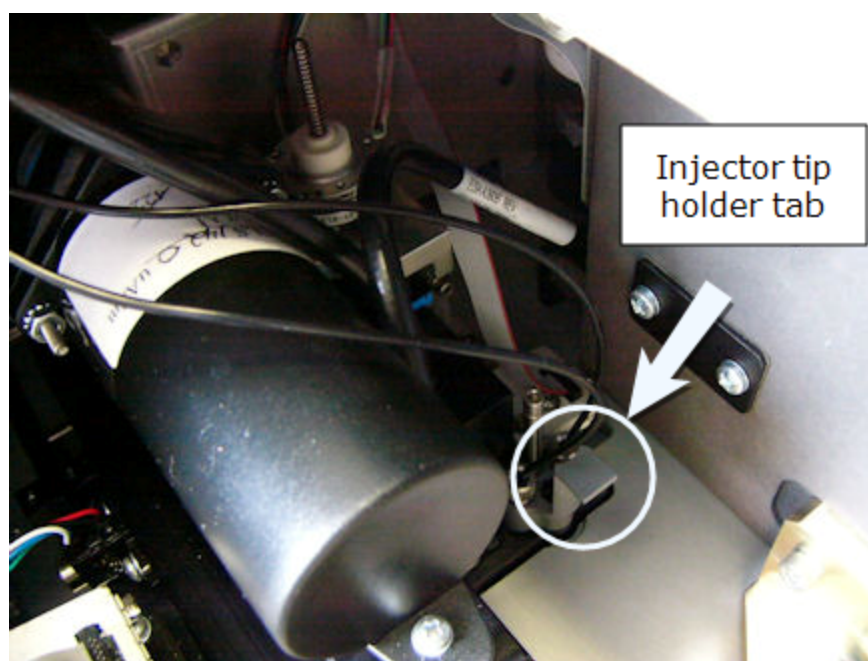

Figure 2-3: Injector tip holder in its socket

11. Seat the light shield in the reader's cover and finger-tighten the thumbscrews to secure it.

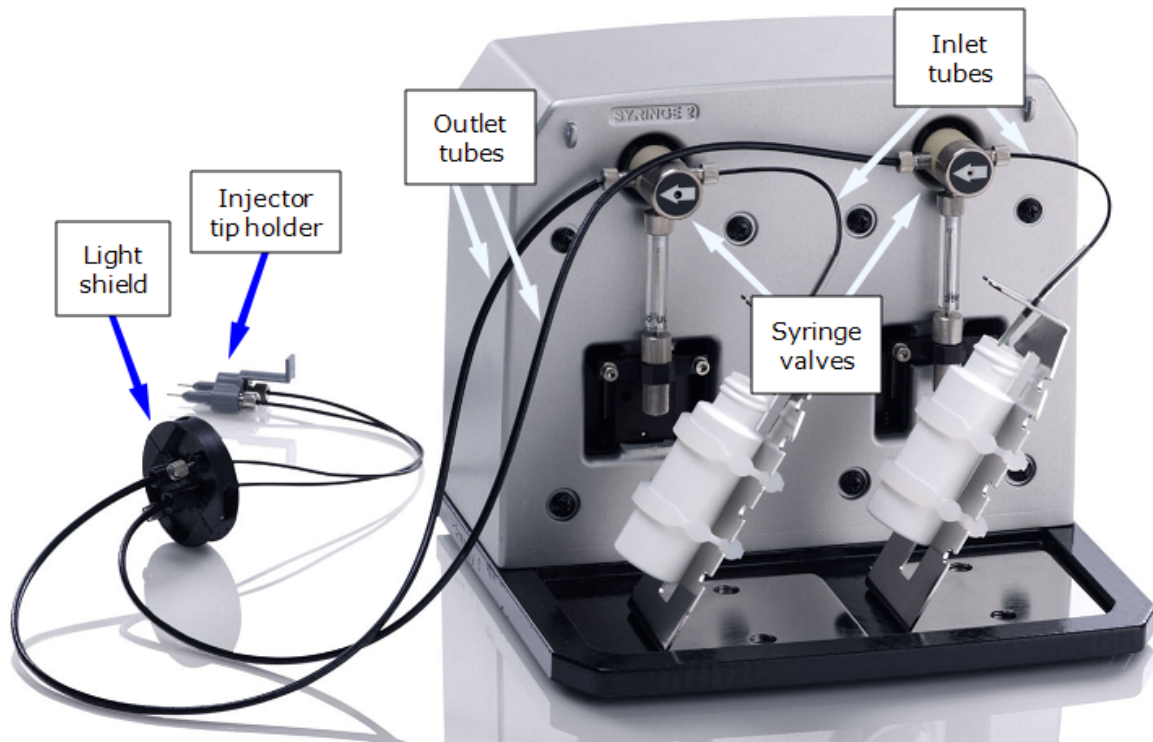

Figure 2-4: Dispense module components

12. Remove the two syringes from their protective boxes. They are identical and interchangeable. Each syringe should already be assembled in one piece, but if for some reason there are two separate pieces, assemble them now: insert the white tip of the syringe plunger into the barrel of the syringe and gently push it all the way into the barrel.
13. Install the syringes, referring to [Figure 2-5](#) on page 16:
 - Hold the syringe vertically with the threaded end at the top.
 - Screw the top of the syringe into the bottom of the syringe valve. Finger-tighten only.
 - Carefully pull down the bottom of the syringe until it rests inside the hole in the bracket.
 - Pass a thumbscrew up through this hole and thread it into the bottom of the syringe. Hold the syringe to prevent it from rotating while tightening the thumbscrew. Finger-tighten only.

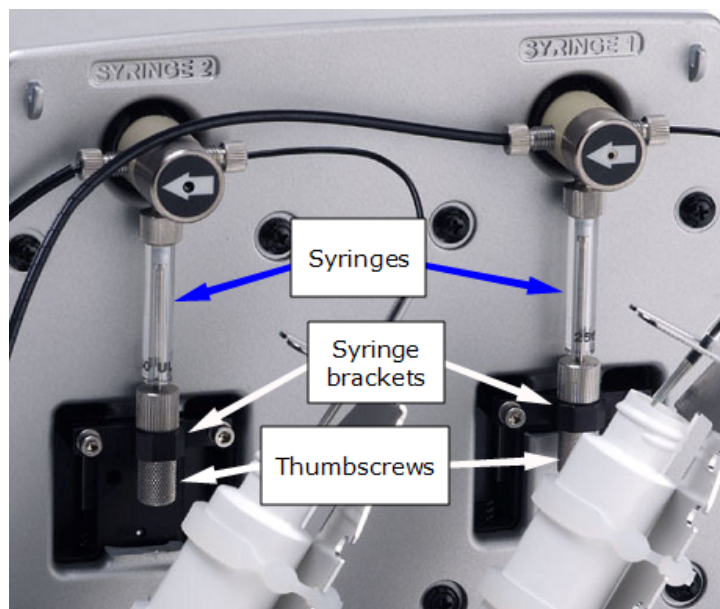

Figure 2-5: Syringe installation

14. Locate the dispense module cable. Plug one end into the port on the left side of the dispense module. Plug the other end into the "Dispenser Port" on the rear of the reader.
15. Locate the injector tip-cleaning stylus, packaged in a small cylinder. Attach the cylinder to the back of the dispense module for storage.

8: Connect the Host Computer

The Synergy H1 is equipped with two communication ports, "USB" and "RS232" (serial), located on the back of the reader. Connect one end of the supplied communication cable to the appropriate port on the reader, and the other end to an appropriate port on the host computer.

9: Install Gen5 Software



The Synergy H1 is controlled by Gen5 software running on a host computer. There is a certain sequence of events that must be followed to ensure that the software is properly installed and configured. Please follow the instructions provided in the *Gen5 Getting Started Guide* to install the software.

10: Turn on the Reader

1. If Gen5 is open, close it now.
2. The power switch is located on the lower-left corner of the front panel; turn on the Synergy H1. The reader performs a System Test. When the test is completed, the reader extends the microplate carrier.

The carrier eject button, located next to the reader's power switch, can be used to extend/retract the microplate carrier.

11: Establish Communication

If using the USB cable, refer to the instructions that shipped with the USB drivers on the Gen5 software media to install the necessary drivers.

1. Start Gen5 and log in if prompted.
2. From the main screen select **System > Instrument Configuration**.
3. Click **Add Reader** and select **Synergy H1**. Click **OK**.
4. Perform one of the following steps, as applicable:
 - Select **Plug & Play**. (A reader must be connected to the computer and turned on to appear in the Available Plug & Play Readers list.)
 - Select **Com Port** and select the computer's COM port to which the reader is connected. (If using the USB cable, the information can be found via the Windows Control Panel, under Ports in the Hardware/Device Manager area of System Properties.)
5. Click **Test Comm**. Gen5 attempts to communicate with the reader. If the communication attempt is successful, return to Gen5's main screen.

If the communication attempt is not successful, try the following:

- Is the reader connected to the power supply and turned on?
- Is the communication cable firmly attached to both the reader and the computer?
- Did you select the correct Reader Type in Gen5?
- Try a different Com port.
- Did you install the USB driver software?
- If you remain unable to get Gen5 and the reader to communicate with each other, contact BioTek's Technical Assistance Center.

12: Verify/Set Dispenser Calibration Values

Applies only to models equipped with injectors

Confirm that the reader is configured with calibration values for the dispense module.

① The calibration values for both dispensers (#1 and #2) are printed on labels affixed to the rear of the dispense module. Each label lists six target calibration values (e.g., 200, 80, 40) with their actual measured values (e.g., 199.3, 79.7, 39.9). Gen5 should display the **measured** calibration values.

1. If you have not already done so, turn on the instrument and establish communication with Gen5.
2. In Gen5, go to **System > Instrument Configuration**, select the **Synergy H1**, and click **View/Modify**.
3. Click **Setup** and select the **Dispenser 1** tab.
4. Click **Get Volumes**.
5. Compare the Calibration Volumes in the dialog with the Syringe #1 values on the rear panel of the dispense module.

If the values match, skip to step 6.

If there is a mismatch:

- Press CTRL+SHIFT+M to enter maintenance mode for the Dispenser 1 window.
 - Enter the syringe calibration values from the corresponding label on the rear of the dispense module.
 - Click **Send Volumes** and then **Get Volumes** to verify that the entered values were sent to the reader.
6. Select the **Dispenser 2** tab and repeat steps 4–5 for Dispenser 2.

13: Run a System Test

Running a System Test will confirm that the reader is set up and operating properly, or will provide an error code if a problem is detected.

1. Turn on the incubator:
 - In Gen5, select **System > Instrument Control > Synergy H1**.
 - Click the **Pre-Heating** tab. Enter a Requested temperature of at least 37°C and then click **On**.

Wait until the incubator temperature reaches the set point before continuing.

2. Select **System > Diagnostics > Run System Test**. Select your reader if prompted and click **OK**.
3. When the test is complete, a dialog requesting additional information appears. Enter the information and click **OK**.

If a message appears stating that the reader has a *pending* system test report, view the report and then repeat steps 2 and 3.

4. The results report appears and should contain the text "SYSTEM TEST PASS".
 - If required, print the report and store it with your installation records. Note: Gen5 stores results in its database; you can print a report at any time.

If an error code is returned, refer to **Error Codes** starting on page 145. If the problem is something you can fix, do so now and run another System Test. If the problem is something you cannot fix, or if the test continues to fail, contact BioTek's Technical Assistance Center.

5. Turn off the incubator.

Models with injectors: Keep Gen5 open and proceed to the next section.

All other models: The installation and setup process is complete. Close Gen5 and proceed to [Operational/Performance Qualification](#) on page 21.

14: Test the Injection System

Applies only to models equipped with injectors

1. If necessary, press the carrier eject button to eject the microplate carrier.
2. Place the tip priming trough in its pocket in the carrier.
3. Place the priming plate on the carrier.

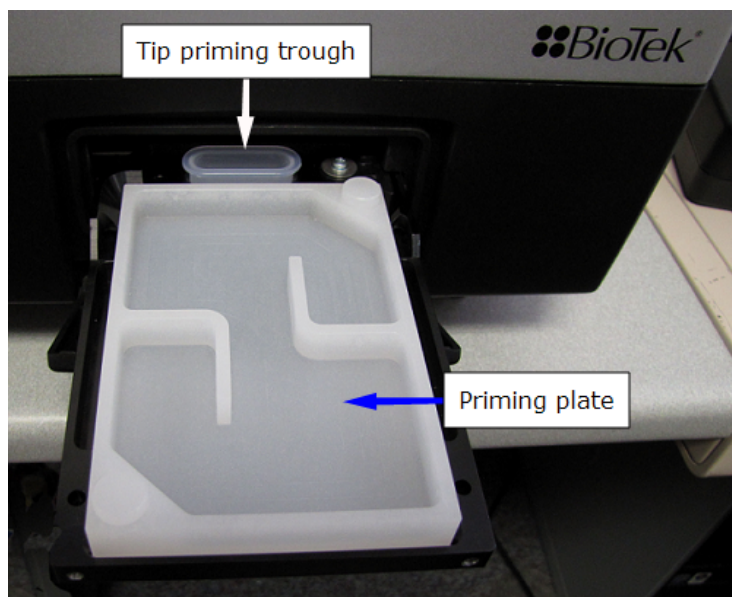

Figure 2-6: Priming trough and plate installed on the carrier

4. Fill the two reagent bottles with distilled or deionized water. Place the bottles in their holders, and place the holders directly in front of the syringes. Insert the inlet tubes into the bottles.
5. In Gen5, select **System > Instrument Control > Synergy H1** and click the **Prime** tab.
6. With Dispenser set to 1, set the Volume to 5000 μL and click **Prime**. The syringe should move down and up repeatedly, drawing fluid from the bottle and pumping it through the tubing and into the priming plate. Examine the fittings; no leaks should be detected. If leaks are detected, tighten all fittings and repeat the prime. If leaks are still detected, contact BioTek's Technical Assistance Center.
7. When finished, set the Volume to 2000 μL and click **Purge** to clear the fluid lines.
8. Set the Dispenser to 2 and repeat steps 6 and 7.
9. Remove and empty the priming plate.

Operational/Performance Qualification

Your Synergy H1 was fully tested at BioTek prior to shipment and should operate properly following the successful completion of the installation and setup procedures described in this chapter.

If you suspect that problems occurred during shipment, if you received the reader back from BioTek following service or repair, or if regulatory requirements dictate that Operational/Performance Qualification is necessary, turn to **Instrument Qualification Procedures** starting on page [107](#) to learn about BioTek's recommended OQ/PQ procedures for the Synergy H1.

A Product Qualification & Maintenance (IQ/OQ/PQ) package for the Synergy H1 is available for purchase (BTI #8040528). Contact your local BioTek dealer for more information.

Repackaging and Shipping Instructions



If the equipment has been exposed to potentially hazardous material, decontaminate it to minimize the risk to all who come in contact with the reader during shipping, handling, and servicing. Decontamination prior to shipping is required by the U.S. Department of Transportation regulations. See page 66 for decontamination instructions for the reader and dispense module.

Remove the microplate and tip prime trough (if equipped) from the carrier before shipment. Spilled fluids can contaminate the optics and damage the instrument.

The Synergy H1 with all available modules weighs up to 55 pounds (24.95 kg). Use two people when lifting and carrying the instrument.



The instrument's packaging design is subject to change. If the instructions in this section do not apply to the packaging materials you are using, please contact BioTek's Technical Assistance Center.

Replace the shipping hardware before repackaging the reader. Please contact BioTek and order part number 8040015 if you need a carrier shipping bracket and/or filter reader shipping bracket.

When preparing to ship the Synergy H1 and/or the dispense module to BioTek, be sure to use the original packaging materials. Other forms of commercially available packaging are not recommended and can **void the warranty**.

The shipping materials are designed to be used no more than five times. If the original materials have been damaged, lost, or used more than five times, contact BioTek to order replacements.

Refer to the *Gas Controller User Guide* for the decontamination procedure and packing instructions for the gas controller module.

1. Contact BioTek's Technical Assistance Center for a Service Call Notice (SCN) number and the shipping address.
2. Decontaminate the reader and, if attached, the dispense module, according to the instructions provided in *Decontamination* starting on page 66.
3. If you will also be shipping the dispense module, perform the steps described on page 25.

If you are not shipping the dispense module, disconnect it from the reader now.

4. If applicable, remove the tip priming trough from the microplate carrier.
5. Retract the microplate carrier. Turn off and unplug the reader.
6. Install the carrier shipping bracket and, if applicable, the filter reader shipping bracket. See [Figure 2-1](#) on page 10.
7. Place the accessories in the accessories box and then seal the box with tape.

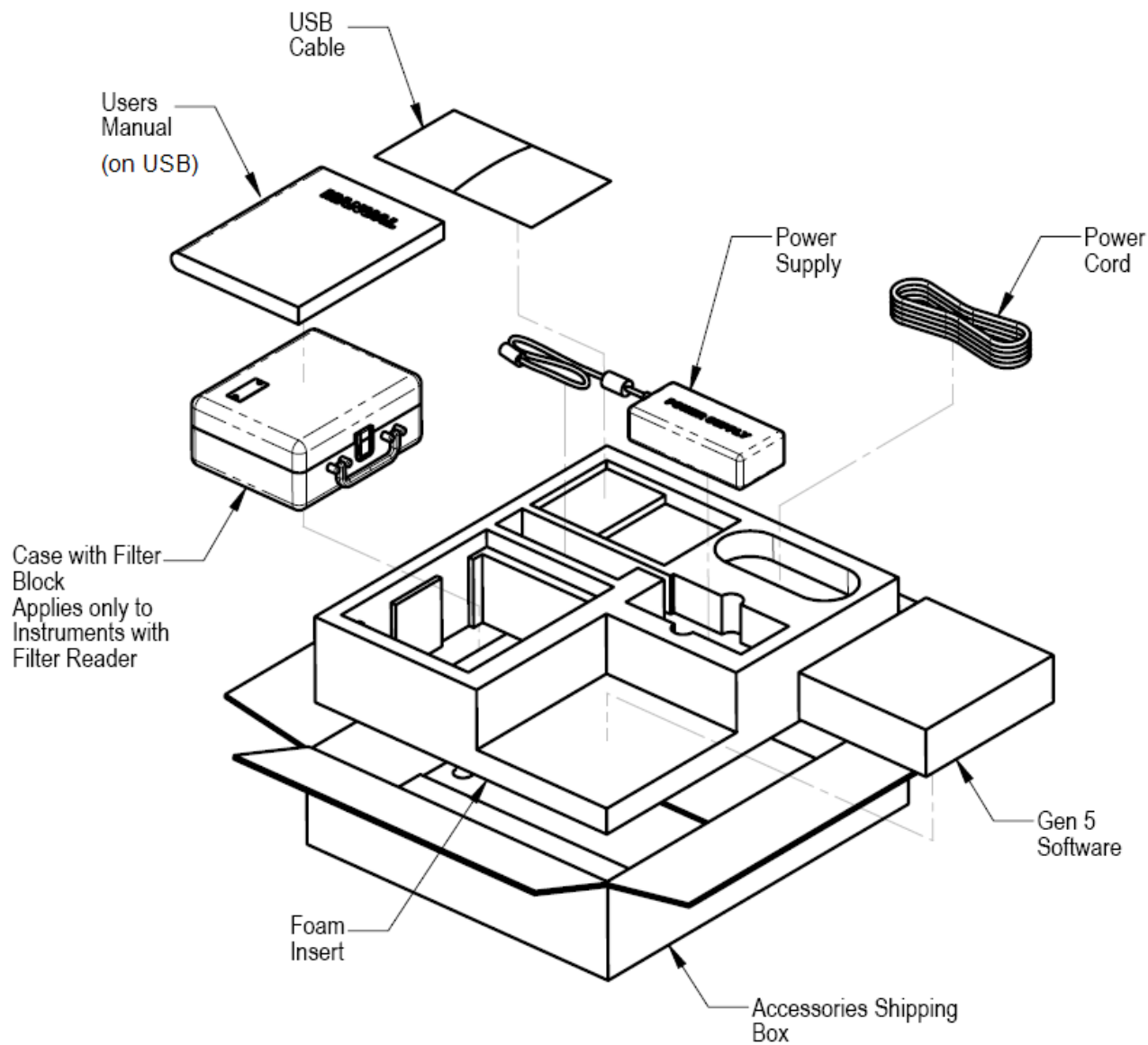

Figure 2-7: Repacking the Synergy H1 accessories box

8. Place the instrument in a plastic bag.
9. Place the instrument in the shipping box with foam corners.
10. Place the accessories box in the shipping box. Seal the box with tape.

11. When finished, write the SCN number on the outside of the box and ship the box to BioTek.

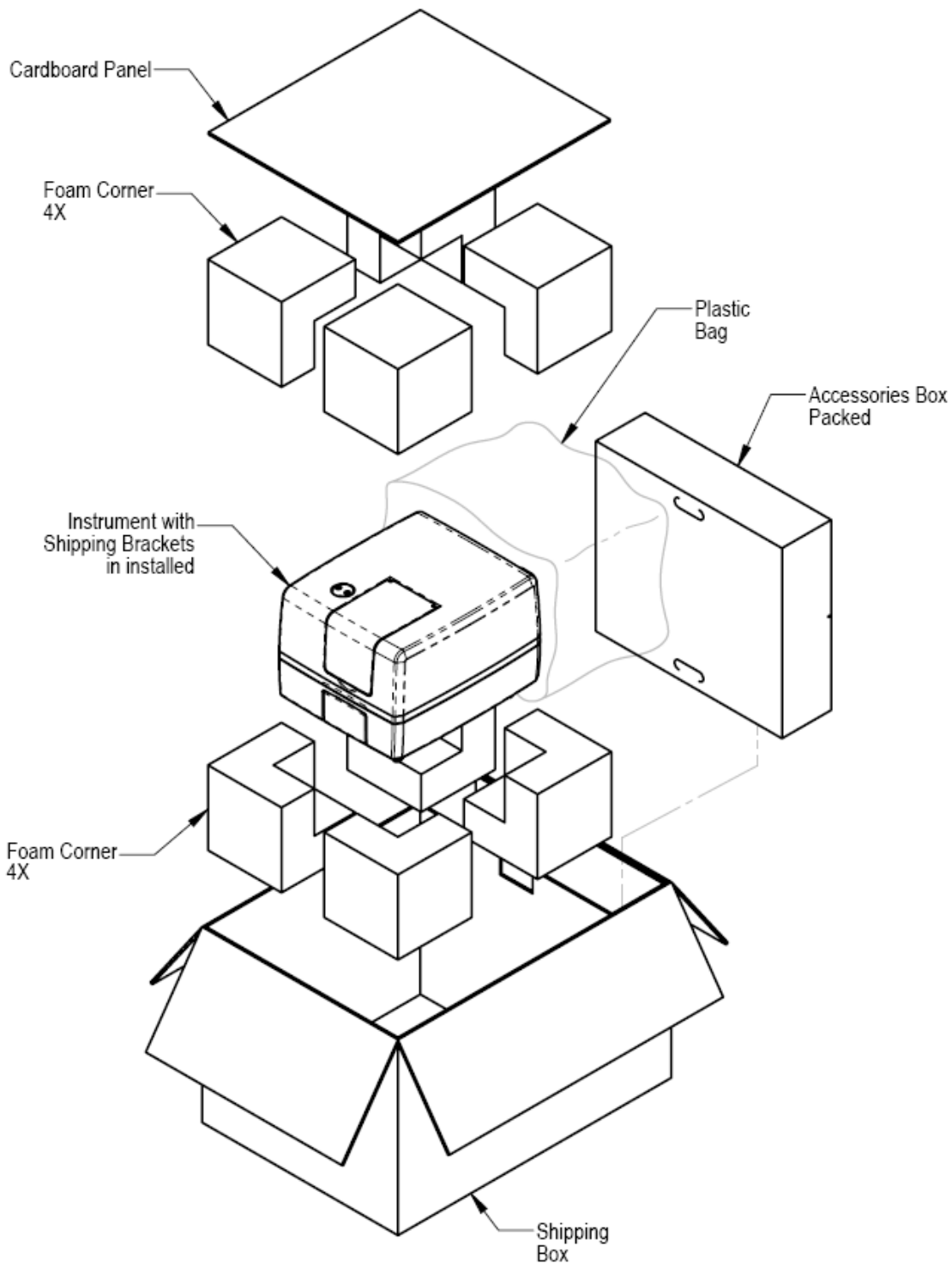

Figure 2-8: Repacking the instrument and accessories box

Prepare the Dispense Module for Shipment

Refer to the illustrations on the next two pages when performing these steps.

1. If you have not already done so, contact BioTek's Technical Assistance Center for a Service Call Notice (SCN) number and the shipping address before returning equipment for service.
2. Decontaminate the module according to the instructions starting on page 66. Be sure to purge the dispense module of all fluid when finished.
3. With the reader on, start Gen5 and select **System > Instrument Control > Synergy H1**.
4. Perform this step twice, once per dispenser: Click the **Prime** tab (or **Dispenser** tab, if using Gen5 v2.05 or lower) and set the number (1 or 2). Click **Maintenance**. The syringe bracket lowers. Remove the thumbscrew from underneath the bracket. Carefully unscrew the top of the syringe from the syringe valve. Lift out the syringe and store it in its original box.
5. Fully detach the dispense module from the reader. Set the module aside for the moment.
6. Remove the tip priming trough and store it in the dispenser accessories bag.
7. Remove the two inlet tubes from the syringe valves and store them in their plastic canisters.
8. Remove the two outlet tubes from the syringe valves. Attach the clear plastic shrouds to the fittings of the outlet tubes. Place the tubes in a plastic bag.
9. Remove the front cover from the dispenser.
10. Insert the bottom foam end cap in the dispenser module accessories shipping box and place the accessories in the insert.
11. Insert the bottom foam end cap in the shipping box, and place the dispense module inside the end cap.
12. Insert the foam insert that holds the reagent bottle holders and injector tubing into the shipping box and place the bottle holders and tubing in it.
13. Slide the dispenser accessories box into the shipping box.
14. Insert the top foam end cap. Close and seal the outer box with tape.
15. Write the SCN number on the outside of the box. Ship the box to BioTek.

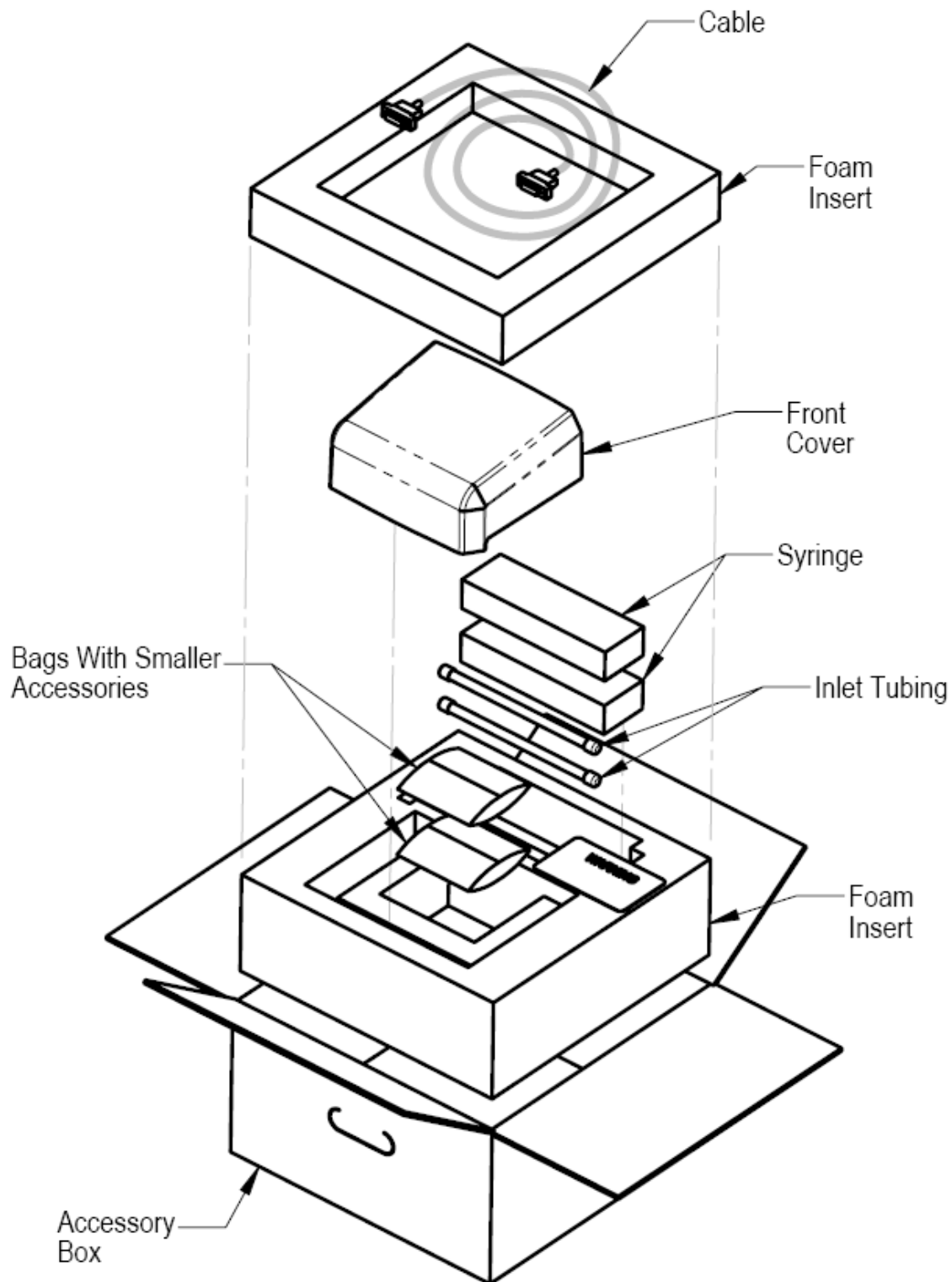

Figure 2-9: Packing the dispense module accessories

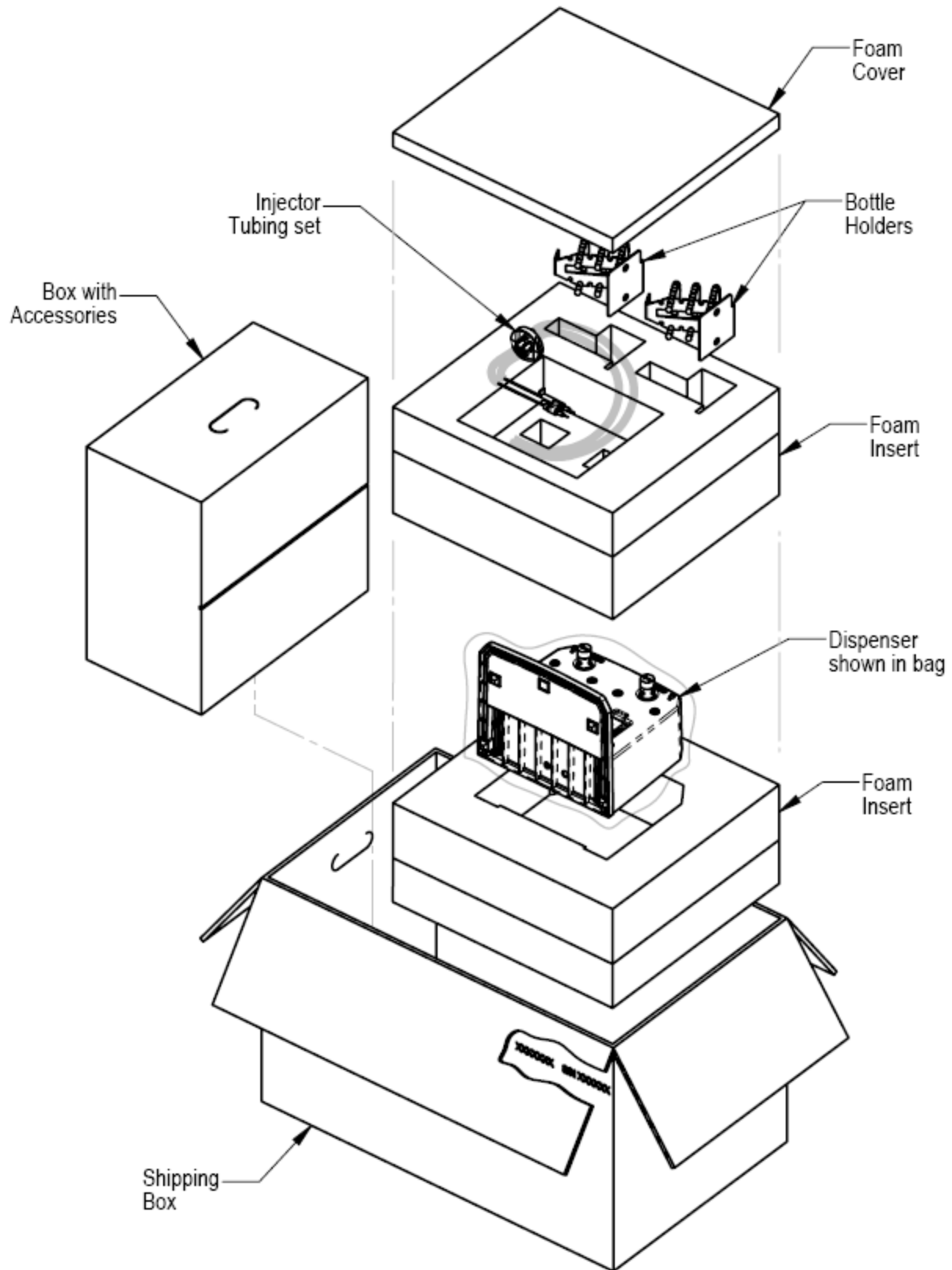

Figure 2-10: Packing the dispense module

Getting Started

This chapter describes some of the Synergy H1's external and internal components, and provides an introduction to using Gen5 software to control the instrument and, if equipped, dispense module.

Modular Design	30
External Components	31
Internal Components	31
Filter Cube	32
Injection System	33
Gen5 Software	35
Define the Filter Cube in Gen5 and on the Reader	35
Protocols and Experiments	36
Dispense Module Control	37
Plate Shaking Options	38
Recommendations for Optimum Performance	39
General	39
Luminescence Measurements	40
Monochromator-Based Fluorescence Systems	40
Models with Injectors	40
Incubation and Partial Plates	40
Kinetic Assays Using the Continuous Shake Feature	41

Modular Design

The Synergy H1 is a multi-mode microplate reader, with a design that allows you to initially purchase only the capabilities you need and then upgrade later as your requirements expand. Please contact BioTek Customer Care to learn more about your upgrade options.

Gen5 software is used to control the reader. If the reader is connected and turned on, Gen5 will present you with only those options that apply to your reader model. For example, if your model is not equipped with injectors, Gen5 will not provide the option to add a Dispense step to your assay protocol.

The instrument's part number indicates its capabilities:

Part Number	Description
H1F	Filter-based optics, top only
H1M	Monochromator-based optics, top and bottom
H1MF	Monochromator- and filter-based optics
H1FD	Filter-based optics and dispense module
H1MD	Monochromator-based optics and dispense module
H1MFD	Monochromator- and filter-based optics and dispense module
H1FG	Filter-based optics and gas controller module
H1MG	Monochromator-based optics and gas controller module
H1MFG	Monochromator- and filter-based optics and gas controller module
H1FDG	Filter-based optics with dispense module and gas controller module
H1MDG	Monochromator-based optics with dispense module and gas controller module
H1MFDG	Monochromator- and filter-based optics with dispense module and gas controller module

External Components

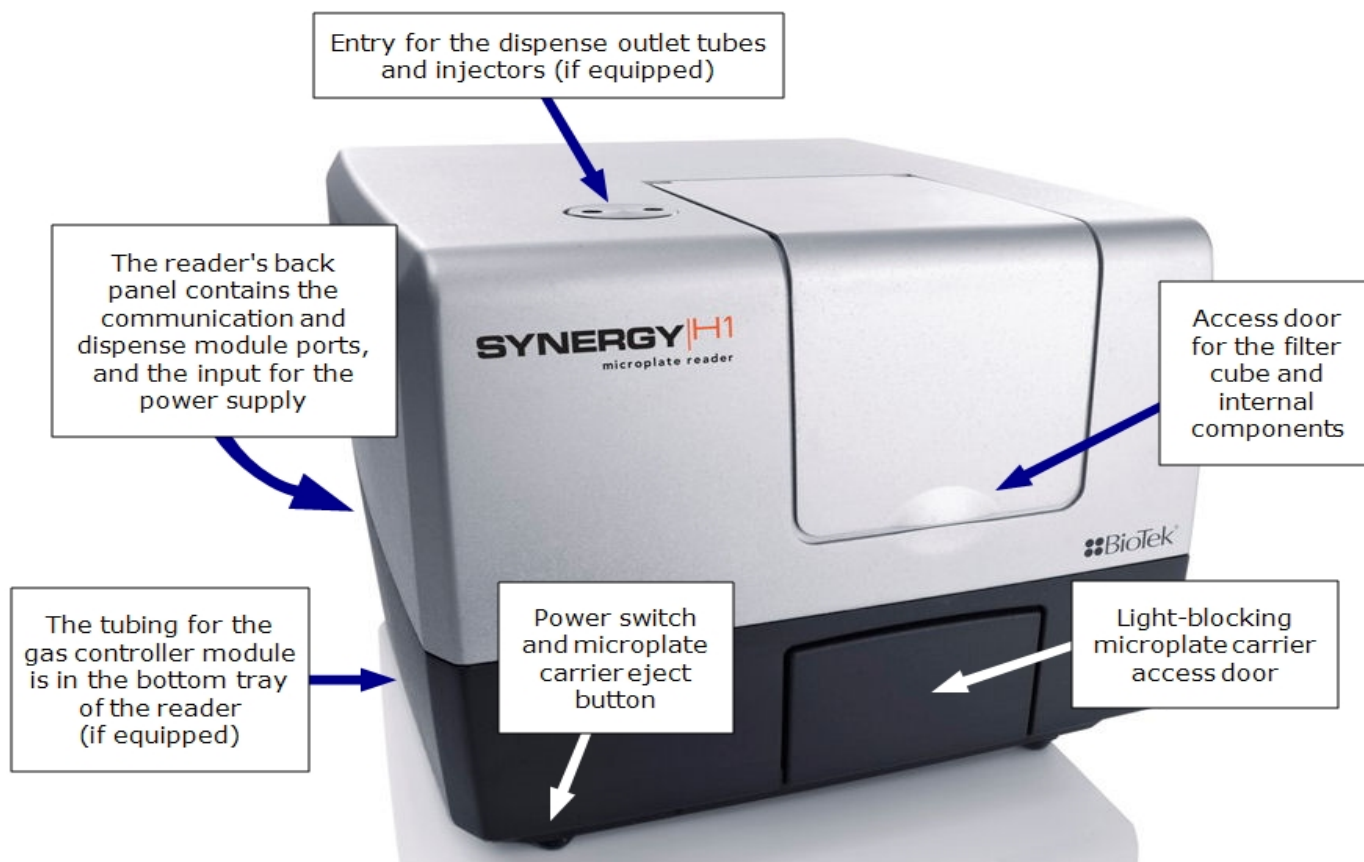

Figure 3-1: Synergy H1, front view

Internal Components

As discussed on page 30, not all Synergy H1 models contain these components.

Component	Description
Filter Cube	The filter cube can contain excitation and emission filters, mirrors, and polarizing filters. Preconfigured cubes are available from BioTek, or you can change the filters and mirrors yourself. See Filter Cube on page 32.
Injection System	The syringes may require replacement over time. The tubing and injectors require cleaning at regular intervals. Applies to models with injectors and an external dispense module. See Injection System on page 31.

Filter Cube

Most Synergy H1 models are equipped with a filter cube that contains excitation and emission filters, mirrors, and, if required, polarizing filters.

Excitation and emission filters are used for obtaining fluorescence and luminescence measurements. The excitation filter selects the band of light to which the sample will be exposed. The emission filter selects the band of light with the maximum fluorescence signal of the sample, to be measured by the photomultiplier tube (PMT).

For filter-based, top-reading fluorescence analysis, the Synergy H1 uses mirrors to direct the excitation and emission light paths. Mirrors are required for fluorescence polarization (FP) measurements to direct light to the sample, because fibers cannot carry polarized light. Mirrors also provide increased gain/sensitivity for fluorescence intensity (FI) and time-resolved fluorescence (TRF) measurements. The filter cube stores up to two mirrors and there are two possible mirror types:

- A **50%** mirror is a glass slide with silver dots. It works with any wavelength in the range of 200 to 850 nm.
- A **dichroic** mirror is wavelength-specific: It requires the excitation and emission filters to fall within specific ranges. Dichroic mirrors provide better sensitivity than 50% mirrors, but they are dye-specific.

Filters and mirrors are stored in the filter cube as described in [Filter Cube Overview](#) starting on page 44. If you run different types of fluorescence or luminescence assays, you can replace the entire filter cube with a different one; this is the BioTek-recommended option. Alternatively, you can install different filters or mirrors in the cube. Contact BioTek for information on purchasing additional cubes, filters, and mirrors.



The reader is delivered with a filter cube installed, and the reader's onboard software is configured with the filter and mirror values and their locations in that filter cube. When Gen5 communicates with the reader, it requests this information and stores the values in a Filter Cube table.

It is critical that the values in Gen5 and onboard the reader exactly match the contents of the installed filter cube. If you exchange the filter cube or modify its contents, you **must** update Gen5's Filter Cube table and send the new information to the reader; see instructions on page 35.

The filter cube is accessed through a hinged door in the front of the instrument. Do not open the door to access the filter cube during instrument operation! Doing so may result in invalid data.

Learn more about exchanging and modifying filter cubes in the [Filters and Mirrors](#) chapter.

Injection System

- The tubing and injectors should be cleaned at least every three months. See [Clean the Dispense Tubes and Injectors](#) on page 63 for instructions.
- Inspect the injection system daily for leaks, preferably immediately after priming and whenever plumbing changes have been made.
- If a syringe is leaking, it may need to be replaced. See [Dispense Module, Syringe Replacement](#) on page 71 for instructions.

Dispense Module

The dispense module sits on top of the reader and pumps fluid from the reagent bottles to injectors located inside the instrument. Fluid is injected into one well at a time. The injectors support plate types from 6- to 384-well plates.

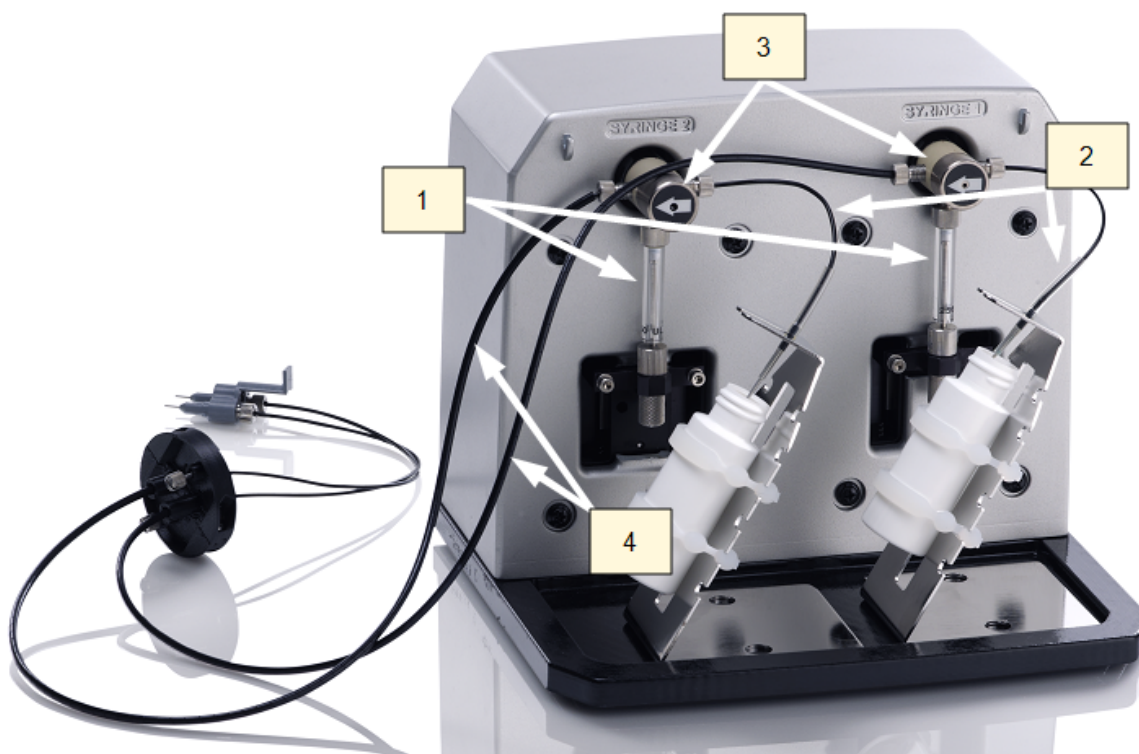

Figure 3-2: Dispense module components

1	Two 250- μ L syringes draw fluid from the supply bottles.
2	Inlet tubes transport fluid from the supply bottles to the syringes. These tubes are short pieces of opaque PTFE (Teflon) tubing connected to stainless-steel probes on one end and threaded fittings on the other end.
3	Valves switch the syringe flow from the inlet tubes to the outlet tubes.

4	Outlet tubes transport fluid from the syringes into the instrument, through the tubing ports on the reader's top cover. The outlet tubes are opaque PTFE tubes with threaded fittings on each end.
---	--



Avoid continuous contact with harsh chemicals. Rinse the fluid path with deionized water after contact with any strong acid, base, or solvent.

For information on the materials used in the injection system, refer to *Injection System - Chemical Compatibility Technical Note* on the USB flash drive supplied with the Synergy H1.

Priming the Injection System

Before running a Dispense assay, use Gen5 to prime the system with the reagent or dispensing fluid. An additional tip prime can be performed at the start of the assay and, sometimes, just before each dispense to a well. The tip prime compensates for any fluid loss at the injector tip due to evaporation since the last dispense. All priming activities are controlled using Gen5 (see [Dispense Module Control](#) on page 37).



If the injection system is not adequately primed, air bubbles can get trapped in the system and affect injection volumes. Air bubbles in the system can also result in fluid spraying or scattering inside the reader.

Both types of primes require a fluid reservoir to be present on the microplate carrier. See the photo in [Test the Injection System](#) on page 20.

- The priming plate is placed on the microplate carrier for a Prime operation (to prime the dispense system with fluid).
- The tip priming trough is placed in the rear pocket of the carrier, and is used for performing the Tip Prime before dispensing. The trough holds up to 1.5 mL of liquid and must be periodically emptied and cleaned by the user.



Do not perform tip priming when using tall plates. Generally, plates with fewer than 96 wells are too tall for error-free tip priming; and, tip priming is rarely required for these larger-volume plates.

The priming plate should be empty before priming, and it should contain fluid after priming.

Gen5 Software

Gen5 supports all Synergy H1 models. Use Gen5 to control the reader, the dispense module (if equipped), and the BioStack (if equipped); perform data reduction and analysis on the measurement values; print or export results; and more. This section provides brief instructions for working with Gen5 to create protocols and experiments and read plates. Refer to the *Gen5 Getting Started Guide* and the Help system for more information.

Define the Filter Cube in Gen5 and on the Reader

As described on page 32, most Synergy H1 models are delivered with a filter cube installed, and the reader's onboard software is configured with the filter and mirror values and their locations in that filter cube. When Gen5 communicates with the reader, it "asks" for this information and then stores the values in a Filter Cube table.



Important! It is critical that the values in Gen5 and the reader's software exactly match the contents of the installed filter cube.

If you exchange or modify the filter cube, you must update the Gen5 Filter Cube table and send the information to the reader:

1. From the Gen5 main view, select **System > Instrument Configuration**. Highlight the **Synergy H1**, click **View/Modify** and then click **Setup**.
2. If this is a new filter cube, enter a unique name to identify the cube and then enter a name for Filter Set 1.
3. *If applicable*, check the Fluorescence Polarization Cube box.
4. Define/modify settings for the excitation and emission filters:
 - Select **Band Pass**, **Long Pass**, or **Short Pass**, as appropriate for each filter type.

Band Pass	a standard interference filter with a defined central wavelength and bandwidth
Long Pass	cutoff filter that transmits longer wavelengths and block shorter wavelengths
Short Pass	cutoff filter that transmits shorter wavelengths and block longer wavelengths

- Select **PLUG** to indicate the presence of a plug.
- Select **HOLE** to indicate an empty location.

5. Select the mirror type and enter the excitation and emission ranges. (Note that the "M" value on the filter cube label is the cut-off (nm). Refer to the mirror information table on page 48.)

① If 'Fluorescence Polarization Cube' is checked, only Filter Set 1 is required for definition. The filters and mirrors of Filter Set 2 must be identical to those of Filter Set 1 for FP.

6. Define Filter Set 2, if necessary.
7. Click **Send Values** to transfer the information to the reader.
8. When finished, click **Close**.

Protocols and Experiments

In Gen5, a protocol contains instructions for controlling the reader and (optionally) for analyzing data retrieved from the reader. At a minimum, a protocol must specify the procedure for the assay you wish to run. After creating a protocol, create an experiment that references the protocol. You'll run the experiment to read plates and analyze the data.

These instructions briefly describe how to create a protocol in Gen5. See the Gen5 Help system for complete instructions.

1. In the Gen5 Task Manager, select the Protocols icon and click **Create New**.
2. Open the Procedure dialog (double-click Procedure in the menu tree).
3. Select an appropriate Plate Type.



Gen5 stores measurements and other characteristics for individual plate types in a database. It is essential that you select (or define) the plate type to match the assay plate. Otherwise, **results may be invalid**. See the "Plate Type Database" topic in the Gen5 Help for instructions.

4. Add steps to the procedure to shake or heat the plate, dispense fluid, read the plate, and more.
5. Click **Validate** to verify that the attached reader supports the defined steps, and then close the Procedure dialog.
6. Optionally, perform any of these steps to analyze and report the results:
 - Open the Plate Layout dialog and assign blanks, samples, controls, and/or standards to the plate.
 - Open the Data Reduction dialog to add data reduction steps. Categories include Transformations, Well Analysis, Curve Analysis, and Qualitative Analysis.
 - Create a report or export template via the Report/Export Builders.
7. Select **File > Save** and give the protocol an identifying name.

These instructions briefly describe how to create an experiment and then read a plate in Gen5. See the Gen5 Help system for complete instructions.

1. In the Gen5 Task Manager, select the Experiments icon and click **Create using an existing protocol**.
2. Select the desired protocol and click **OK**.
3. Select a plate in the menu tree and select **Plate > Read Plate #** or click the **Read New** icon.
4. When the read is complete, measurement values appear in Gen5.
5. Select **File > Save** and give the experiment an identifying name.

Dispense Module Control

Applies only to models equipped with injectors

Gen5 is used to perform several dispense functions, such as initialize, dispense, prime, and purge. The Prime and Purge functions are introduced here; refer to the Gen5 Help system for additional information.

Prime

Before running an experiment with a Dispense step, prime the system with the fluid to be used.

1. Place the priming plate on the carrier.
2. Fill the supply bottle with a sufficient volume of the fluid to be used for the prime and the assay. Insert the appropriate inlet tube into the bottle.
3. Select **System > Instrument Control > Synergy H1** and click the **Prime** tab.
4. Select the Dispenser number (1 or 2) associated with the supply bottle.
5. Enter the Volume to be used for the prime. The minimum recommended prime volume is 2000 μL .
6. Select a prime Rate, in $\mu\text{L}/\text{second}$.
7. Click **Prime** to start the process. When finished, carefully remove the priming plate from the carrier and empty it.

If the priming plate is empty, the prime volume was too low.

Purge

To conserve reagent, Gen5 provides the option to purge fluid from the system back into the supply bottle.

1. Select **System > Instrument Control > Synergy H1** and click the **Prime** tab.
2. Select the Dispenser number (1 or 2) associated with the supply bottle.
3. Enter the desired purge Volume in μL (e.g., 2000).

4. Select a prime Rate in $\mu\text{L}/\text{second}$.
5. Click **Purge** to start the process.

Plate Shaking Options

The Synergy H1 supports multiple plate shaking options, as described below. Shaking is controlled using Gen5 by adding a Shake step to a protocol's procedure.

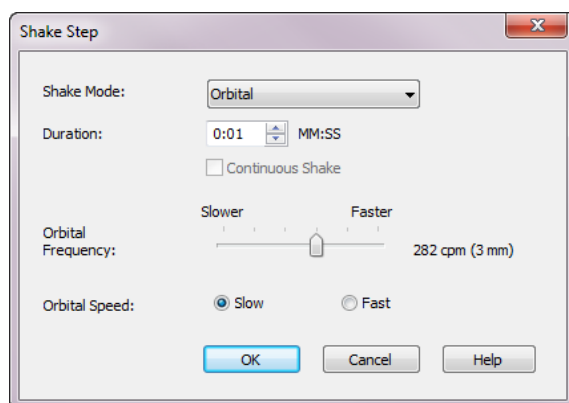

Figure 3-3: Gen5 Shake Step options

Mode	Speed	Amplitude (in 1-mm steps)	Frequency
Linear	-	1 mm to 6 mm	18 Hz to 6 Hz
Orbital	Slow	1 mm to 6 mm	10 Hz to 3 Hz
Orbital	Fast	1 mm to 6 mm	14 Hz to 5 Hz
Double Orbital	Slow	1 mm to 6 mm	~10 Hz to ~3 Hz
Double Orbital	Fast	1 mm to 6 mm	~14 Hz to ~5 Hz

Note: Frequency is based on the Amplitude selected

Recommendations for Optimum Performance

General

- Microplates should be clean and free from dust or bottom scratches. Use new microplates from sealed packages. Do not allow dust to settle on the surface of the solution; use microplate covers or seals when not reading the plate. Filter solutions to remove particulates that could cause erroneous readings.
- Before preparing your microplates, make sure the reader is on and communicating with Gen5. You may want to run a System Test if the reader has not been turned off/on in a few days. Design your Gen5 protocol in advance as well, to ensure that the intended reading parameters are used and to avoid any last-minute corrections.
- Although the Synergy H1 supports standard flat, U-bottom, and V-bottom microplates, the reader achieves optimum performance with flat-bottomed wells when running in Absorbance mode. See **Specifications** starting on page 139 for more information on the supported plates.
- Non-uniformity in the optical density of the well bottoms can cause loss of accuracy, especially with U- and V-bottom polyvinyl microplates. Check for this by reading an empty microplate. Dual wavelength readings can eliminate this problem, or bring the variation in density readings to within acceptable limits for most measurements.
- Inaccuracy in pipetting has a large effect on measurements, especially if smaller volumes of liquid are used. For best results in most cases, use at least 100 μL per well in a 96-well plate, 25 μL in a 384-well plate, and 5 μL in a 1536-well plate (if supported).
- Pipetting solution into 384- [and greater] well plates often traps air bubbles in the wells, which may result in inaccurate readings. A dual-wavelength reading method usually eliminates these inaccuracies. For best results, however, remove the air bubbles by degassing the plate in a vacuum chamber or spinning the plate in a centrifuge before reading.
- The inclination of the meniscus can cause loss of accuracy in some solutions, especially with small volumes. Shake the microplate before reading to help bring it within acceptable limits. Use Tween 20, if possible (or some other wetting agent) to normalize the meniscus for absorbance measurements. Some solutions develop menisci over a period of several minutes. This effect varies with the brand of microplate and the solution composition. As the center of the meniscus drops and shortens the light path, the density readings change. The meniscus shape will stabilize over time.
- Use of liquids with concentrations of acids, corrosives, or solvents of 3% and greater can begin attacking the materials inside the instrument's chamber. Running multiple plates with concentrations <3% in long kinetics may also have a destructive effect. If the experiment is incubated, deterioration of chamber components will be accelerated. When in doubt about the use of acids, corrosives, or solvents; please contact TAC@biotek.com.

- It is the user's responsibility to understand the volumetric limits of the plate type in use as it applies to the assay being run.

Luminescence Measurements

- For highly sensitive Luminescence assays using white plates, add a Delay step to your Procedure to "dark adapt" the plates in the reading chamber before taking measurements.

Monochromator-Based Fluorescence Systems

- Although Time-Resolved Fluorescence can be performed with the monochromator, the filter-based fluorescence system is more sensitive for TRF and is the better choice.

Models with Injectors

- To keep the dispense system in top condition, flush and purge the fluid lines with deionized (DI) water every day or upon completion of an assay run, whichever is more frequent. Some reagents may crystallize or harden after use, clogging the fluid passageways. Flushing the tubing at the end of each day, letting the DI water soak, and then purging the lines at the beginning of each day ensures optimal performance of the dispense system. See the Preventive Maintenance chapter for more information.
- When dispensing volumes less than or equal to 20 μL /well, we recommend specifying a tip prime volume that is equal to the dispense volume. For dispense volumes greater than 20 μL /well, we recommend a tip prime volume of 20 μL .
- To avoid spillage and possible contamination of the instrument, empty the tip prime trough frequently and do not exceed the total fluid volume of the plate well when dispensing.

Incubation and Partial Plates

When performing a partial plate read that includes an incubation step, the following recommendations can reduce the effects of evaporation of your samples:

- Use microplate lids.
- Fill unused wells with liquid.
- Cluster your sample wells rather than spacing them throughout the plate.
- Place your sample wells in the center of the plate. This placement may lead to less evaporation than if you place the samples in wells on the edge of the plate.

Kinetic Assays Using the Continuous Shake Feature

This recommendation applies only to Synergy H1 basecode software versions lower than 2.00.

A Gen5 experiment that specifies the following parameters may not run successfully on the Synergy H1: Continuous Shake, Kinetic Interval greater than 15 minutes

When the experiment is initiated, plate shaking will begin, but shaking may stop prematurely with no error message.

One suggested workaround is to shorten the kinetic interval. For example, if your desired experiment is 25 kinetic reads with 60-minute intervals, use 100 kinetic reads with 15-minute intervals.

Another suggestion is to perform multiple Shake steps and then a Read step with the Discontinuous Kinetic Procedure feature enabled. For example, if your desired experiment looks like this:

Description	Comments
Start Kinetic [Run 24:00:00, Interval 2:00:00]	
Shake: Orbital (Continuously)	
Read: (A) 600	
End Kinetic	

do this (example assumes the Read step takes one minute):

Description	Configuration
Shake: Orbital for 15:00	<input checked="" type="checkbox"/> Discontinuous Kinetic Procedure Estimated total time: 1:00:00 D:HH:MM Estimated interval: 0:02:00 D:HH:MM Number of runs: 13 <input type="checkbox"/> Pause after each run
Shake: Orbital for 15:00	
Shake: Orbital for 15:00	
Shake: Orbital for 15:00	
Shake: Orbital for 15:00	
Shake: Orbital for 15:00	
Shake: Orbital for 15:00	
Shake: Orbital for 15:00	
Shake: Orbital for 14:00	
Read: (A) 600	

Filters and Mirrors

The **Getting Started** chapter provided an overview of the filters and mirrors installed in some Synergy H1 models. This chapter provides more detailed information on working with these components.

Filter Cube Overview	44
Removing a Filter Cube	46
Installing a Filter Cube	46
Configuring the System for Luminescence Measurements	47
About the Gen5 Optics Library	47
Handling Filters and Mirrors	49
Change a Filter or Mirror	49
Clean the Filters and Mirrors	52
Filters and Mirrors Available from BioTek	52

Filter Cube Overview

Most Synergy H1 models are equipped with a filter cube that contains excitation filters, emission filters, and mirrors for use when taking fluorescence and luminescence measurements. Each filter cube contains two filter sets, each of which contains one excitation filter, one emission filter, and one mirror. The filter cube is accessed through a hinged door in the front of the instrument. Each filter has an ID label for recording the cube's contents.



Figure 4-1: Synergy H1 filter cube

You can easily exchange one filter cube with another to meet varying assay requirements. If you regularly need to use different filters or mirrors, consider purchasing additional filter cubes from BioTek.

Use the Gen5 Optics Library to identify and manage the contents of multiple filter cubes; see [About the Gen5 Optics Library](#) on page 47.

The default filter cube configuration is shown below; any changes are reflected in the sales order. Verify that the filter cube contains the filters and mirrors that you ordered. Contact BioTek or your supplier if you did not receive the expected components.

	Position 1	Position 2
Excitation	360/40 nm	485/20 nm
Emission	460/40 nm	528/20 nm
Mirror	400 nm	510 nm

Filters are not specific to either excitation or emission. *Filter direction* within the filter cube is important, and as illustrated in [Figure 4-2](#), the direction differs depending on the filter's placement in the cube (EX or EM). Each filter has its central wavelength and bandpass values printed on its side, with an arrow to indicate the proper direction of light through the filter.

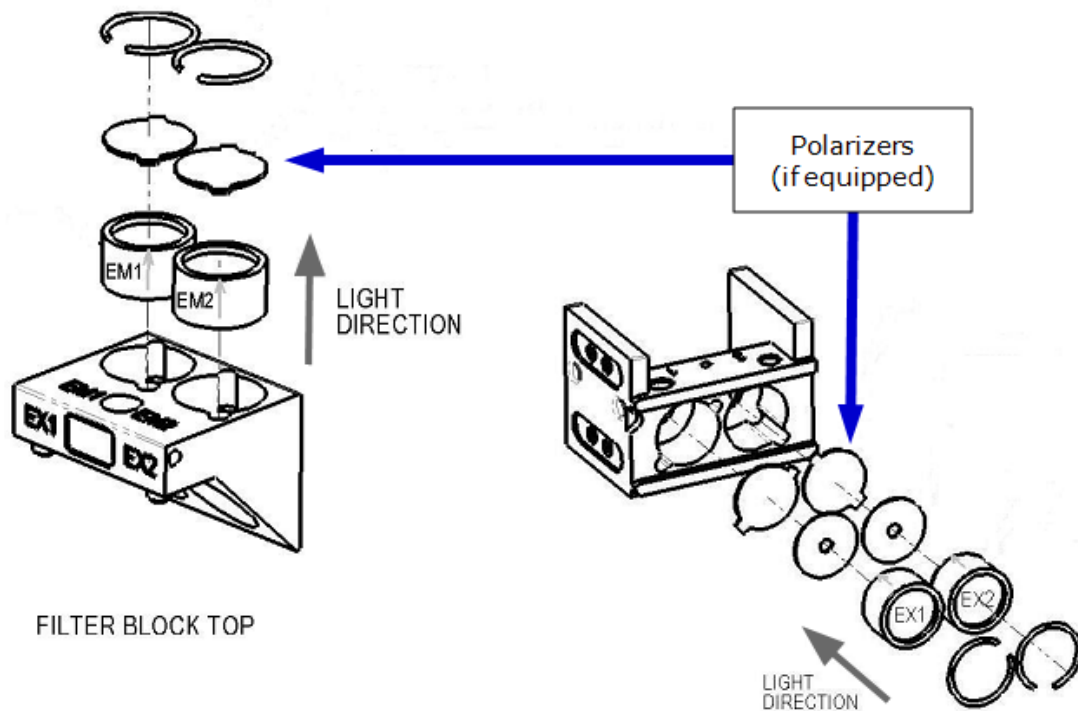

Figure 4-2: Proper orientation of the EX (left) and EM (right) filters in the filter cube

The filter cube can hold up to two half-size, or one full-size, dichroic or 50% mirror. The mirror positions are labeled "1" and "2" to coordinate with EX1/EM1 and EX2/EM2.

Mirror direction is also important. The mirror label should be in the lower-right corner of the mirror and readable (see [Figure 4-3](#) on the next page). If the mirror is positioned incorrectly, your measurement data may be inaccurate.

For Synergy H1 models with FP capability, the cube is equipped with up to four polarizers of the following types:

- Excitation polarizer (visible-range or UV-range)
- Emission polarizer, parallel to the excitation polarizer
- Emission polarizer, perpendicular to the excitation polarizer

Two types of excitation (EX) polarizers are available: visible-range (400 nm and above, the default) or UV-range (300 nm and above, available from BioTek). The polarizers, if used, are placed below the excitation filters and above the emission filters. The polarizer filters are keyed to fit in the correct alignment in the filter cube.

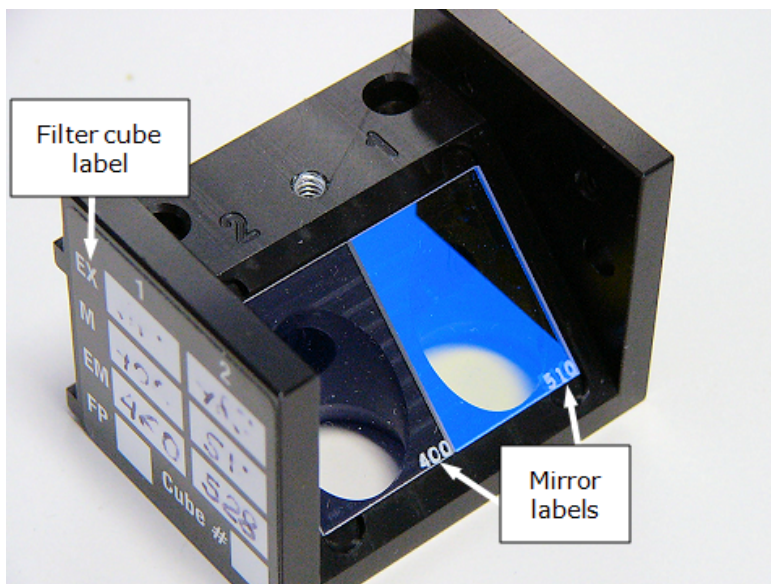

Figure 4-3: Two half-size mirrors positioned in the filter cube, with their labels in the lower-right corners

Removing a Filter Cube



Do not open the access door on the front of the instrument during operation. **Doing so may affect measurements.**

1. Lift up the hinged door on the front of the reader.
2. Grasp the filter cube and slide it to the right to remove it from its chamber.

Installing a Filter Cube

1. Ensure that all filters, plugs, and mirrors are inserted properly in the filter cube (see [Figure 4-2](#) and [Figure 4-3](#)).
2. Open the front access door and locate the filter cube chamber.
3. With the filter cube properly oriented (the non-labeled side entering the chamber), gently slide the cube into the chamber. You will feel a magnet engage the cube. See the photos on the next page.



Figure 4-4: Filter cube sliding into the chamber (left) and properly seated (right)

Configuring the System for Luminescence Measurements



If your tests require that the light emitted from the samples remain unfiltered, the Emission filter position in the filter cube should be empty. As discussed on page 35, if you make any changes to the filter cube, you must update the Gen5 Filter Cube table; select **HOLE** next to Emission to indicate the empty location.

About the Gen5 Optics Library

Gen5 provides an option to create a "library" of the filter cubes used with your assays. You'll define a name and characteristics for each cube, reference the desired cube by name in a protocol, and then update the reader's internal software to match the currently-installed filter cube by selecting **System > Optics Library > Set Reader**. You can also enable a Read Plate Prompt option to alert users at run-time if they attempt to run an experiment that calls for filters/mirrors not currently installed. Brief instructions for adding a filter cube to the library are provided below; refer to the Gen5 help system to learn more.

Adding a Filter Cube to the Gen5 Optics Library

1. From the Gen5 main view, select **System > Optics Library > Filter Cubes**.
2. Click **Add** and enter a name for the filter cube. This name will become available for selection in the protocol/experiment procedure.
3. *If applicable*, check the Fluorescence Polarization Cube box.
4. Enter a name for Filter Set 1.
5. Define the excitation and emission filters:

- Select Band Pass, Long Pass, or Short Pass and enter the wavelength and bandwidth.
 - Select Plug to indicate the presence of a plug.
 - Select Hole to indicate an empty location.
6. Select the mirror type and enter the excitation and emission ranges. Note that the "M" value on the filter cube label is the cut-off (nm).

Cut-off (nm)	Excitation Range	Emission Range
50%	200-850	200-850
320	260-305	335-750
365	290-350	380-800
400	320-390	410-800
435	385-425	445-610
455	400-450	460-710
510	440-505	515-640
525	475-520	530-670
545	512-535	555-578
550	415-540	560-850
555	541-550	560-595
570	515-565	575-735
595	540-590	600-770
635	640-780	400-630
660	580-655	665-850

① If 'Fluorescence Polarization Cube' is checked, only Filter Set 1 is available for definition. The filters and mirrors of Filter Set 2 must be identical to those of Filter Set 1 for fluorescence polarization.

7. Define Filter Set 2, if necessary.
8. Click **OK** to return to the Filter Cubes dialog. Click the Help button to learn about the Read Plate Prompt options.

Handling Filters and Mirrors

Filters and mirrors are stored in a filter cube as described in the overview section starting on page 44. If you run different types of fluorescence and luminescence assays, you can replace the entire filter cube with a different one; this is the BioTek-recommended option. Alternatively, you can install different filters or mirrors in the cube; this section describes how to do this. Contact BioTek for more information on purchasing additional cubes, filters, and mirrors.

Change a Filter or Mirror



Important! After changing the contents of a filter cube, be sure to update Gen5 with the new filter and mirror configuration and then send the information to the reader. It is critical that the Gen5 Filter Cube table reflect the actual location and characteristics of the filters and mirrors in the installed filter cube. See instructions on page 35.

Gather the following tools:

- 7/64" hex key
- Lens paper
- Cotton swab
- Linen or cloth gloves

To remove a filter, plug, or mirror:

① Handle with care. The mirrors are seated on a shelf in the bottom of the cube and are not secured in place.

1. Remove the filter cube as instructed on page 46.
2. Set the cube on a flat work surface (do not hold it in your hand). When you remove the filter cube's top in step 4, the mirrors will fall out if the cube is not on a stable, flat surface.
3. Using a 7/64" hex key, remove the screw and washer located between the two emission filter positions (shown in [Figure 4-5](#)).



Figure 4-5: Removing the screw located between the EM1 and EM2 positions

4. Carefully lift the top off the filter cube.

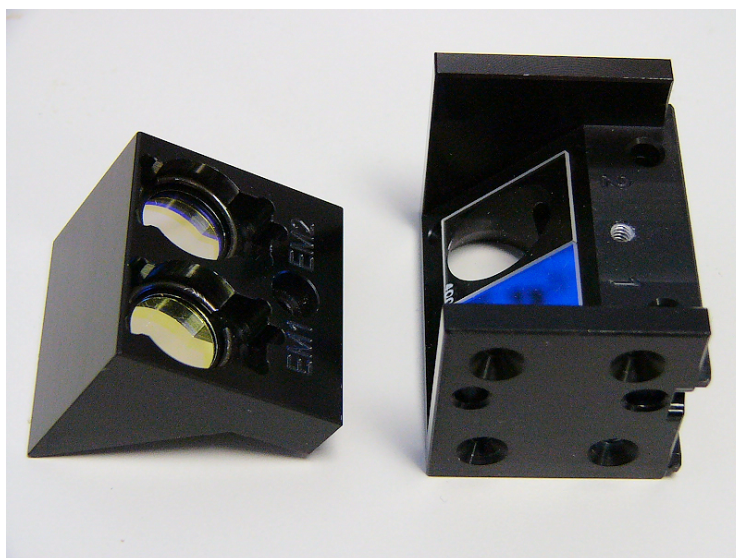

Figure 4-6: Filter cube with the top removed (left), exposing the mirrors (right)



Caution: Do not touch the mirrors with your bare fingers. Wear gloves to reduce the risk of damaging the mirrors or polarizing filters. If you accidentally touch a mirror or polarizing filter with your bare fingers, see **Preventive Maintenance** starting on page 53 for cleaning instructions.

Caution: When removing or replacing a filter or C-clip filter retainer, *do not use a sharp tool*. Use several layers of lens paper and your finger or a cotton swab to remove and replace filters and clips. Using a sharp instrument, such as a flat screwdriver, will scratch the filter surface and make it unusable.

5. The top of the cube contains the emission filters. To remove a filter:
 - a. Prepare a multi-layered cushion of lens paper.
 - b. Using your finger covered with the lens paper, gently push against the filter and its retainer until they pop out.
6. The bottom of the cube contains the mirrors and excitation filters. Remove the mirrors before removing the filters:
 - a. Make note of the mirror placement and label orientation (refer to [Figure 4-3](#) on page 46).
 - b. Wearing linen or cloth gloves, carefully grasp the mirror by its edges, lift it out of the cube, and store it properly.
7. To remove an excitation filter, use a cotton swab to gently push against the filter, the aperture, and the C-clip retainer until they pop out.

To replace a filter, plug, or mirror:

1. To replace a filter or plug:
 - a. Orient the filter as shown in [Figure 4-2](#) on page 45, observing the arrow on its side which indicates the light direction. Drop the filter or plug into the desired location.
 - b. Make note of the filter position number (EX1/EX2 or EM1/EM2).
 - c. Using your fingers, squeeze the sides of the C-clip retainer, and then insert it into the top of the hole containing the new filter. Cover your finger with several layers of lens paper, and then push down on all sides of the retainer until it sits flush against the filter.
 - d. Gently wipe both sides of the filter with lens paper.
2. To replace a mirror, hold the mirror by its edges, turn it so that its label is face-up and readable (see [Figure 4-3](#) on page 46), and place it on the shelf in the filter cube.
3. Place the filter cube top over the bottom and then replace the screw and washer.
4. When finished, install the filter cube in the reader.



Important! If you changed the contents of the filter cube, update Gen5 with the new configuration and then send the information to the reader. It is critical that the Gen5 Filter Cube table reflect the actual location and characteristics of the filters and mirrors in the installed filter cube. See instructions on page 35.

Clean the Filters and Mirrors

Instructions are provided under **Preventive Maintenance** starting on page [53](#).

Filters and Mirrors Available from BioTek

Bandpass filters, plugs, retainer clips, mirrors, empty filter cubes, and other supplies are available for purchase from BioTek. Visit www.biotek.com and go to the Accessories page to see the most up-to-date list. Contact BioTek Customer Care with any questions.

Preventive Maintenance

This chapter provides instructions for maintaining the Synergy H1 and external dispense module (if used) in top condition, to ensure that they continue to perform to specification.

Overview	54
Recommended Maintenance Schedule	55
Warnings and Precautions	56
Clean Exposed Surfaces	57
Inspect/Clean Excitation and Emission Filters	58
Inspect/Clean Mirrors	59
Flush/Purge Fluid Path	61
Run a Dispense Protocol (Optional)	62
Empty/Clean the Tip Priming Trough	63
Clean the Priming Plate	63
Clean the Dispense Tubes and Injectors	63

Overview

A general Preventive Maintenance (PM) regimen for the Synergy H1 includes periodically cleaning all exposed surfaces and inspecting/cleaning the excitation and emission filters and mirrors (if equipped). For models with the external dispense module, additional tasks include flushing/purging the fluid path and cleaning the tip prime trough, priming plate, supply bottles, internal dispense tubing, and injector heads.

Daily Cleaning for the Dispense Module

To ensure accurate performance and a long life for the dispense module and injectors, flush and purge the fluid lines with deionized (DI) water every day or after completing an assay run, whichever is more frequent. Some reagents may crystallize or harden and then clog the fluid passageways. Take special care when using molecules that are active at very low concentrations (e.g., enzymes, inhibitors). Remove any residual reagent in the dispense lines using a suitable cleaning solution (review the reagent's package insert for specific recommendations).

Flushing the tubing at the end of each day, letting the DI water soak overnight, and then purging the lines at the beginning of each day ensures optimal performance of the dispense system. BioTek recommends performing a visual inspection of the dispense accuracy before running an assay protocol that includes dispense steps.

BioTek also recommends flushing the module with DI water before conducting the decontamination procedure described in the [As-Needed Maintenance](#) chapter.



Models with injectors: Accumulated algae, fungi, or mold may require decontamination. See the [As-Needed Maintenance](#) chapter for instructions.

Recommended Maintenance Schedule





The table below contains the recommended Preventive Maintenance tasks for Synergy H1 and the frequency with which each task should be performed.





The risk and performance factors associated with your assays may require that some or all of the Preventive Maintenance procedures be performed more frequently than shown here.

Task	Daily	Quarterly	As Needed
All models:			
Clean exposed surfaces			✓
Inspect/clean excitation and emission filters (if equipped)		✓	
Inspect/clean mirrors (if equipped)			<i>annually</i>
Decontaminate the instrument	<i>before shipment or storage</i>		
Models with injectors and an external dispense module:			
Flush/purge the fluid path	✓		
(Optional) Run a Dispense protocol			✓
Empty/clean tip prime trough	✓		
Clean priming plate			✓
Clean dispense tubes and injectors		✓	✓

Warnings and Precautions

	Warning! Internal Voltage. Turn off and unplug the instrument for all maintenance and repair operations.
	Warning! Wear protective gloves when handling contaminated instruments. Gloved hands should be considered contaminated at all times; keep gloved hands away from eyes, mouth, nose, and ears.
	Warning! Mucous membranes are considered prime entry routes for infectious agents. Wear eye protection and a surgical mask when there is a possibility of aerosol contamination. Intact skin is generally considered an effective barrier against infectious organisms; however, small abrasions and cuts may not always be visible. Wear protective gloves when handling contaminated instruments.
	Caution! The buildup of deposits left by the evaporation of spilled fluids within the read chamber can impact measurements. Be sure to keep System Test records before and after maintenance so that changes can be noted.
	Warning! The instrument with all available modules weighs up to 55 pounds (24.95 kg) depending on the model. Use two people when lifting and carrying the instrument.

	Important! Do not immerse the instrument, spray it with liquid, or use a dripping-wet cloth on it. Do not allow water or other cleaning solution to run into the interior of the instrument. If this happens, contact BioTek's Technical Assistance Center.
	Important! Do not apply lubricants to the microplate carrier or carrier track. Lubricant attracts dust and other particles, which may obstruct the carrier path and cause errors.

Clean Exposed Surfaces

Exposed surfaces may be cleaned (not decontaminated) with a cloth moistened (not soaked) with water or water and a mild detergent.

You will need:

- Deionized or distilled water
- Clean, lint-free cotton cloths or paper towels
- Mild detergent (optional)

Procedure:

1. **Important!** Turn off and unplug the instrument.
2. Wet a cloth or paper towel with water, or with water and mild detergent, and then **thoroughly wring it out so that liquid does not drip from it.**
3. Wipe the plate carrier and all exposed surfaces of the instrument.
4. Wipe all exposed surfaces of the dispense module (if used).
5. Wipe all exposed surfaces of the gas controller module (if used).
6. If detergent was used, wipe all surfaces with a cloth moistened (not soaked) with water.
7. Use a clean, dry cloth to dry all wet surfaces.

Models with injectors: If the tip priming trough overflows or other spills occur inside the instrument, wipe the carrier and the surface beneath the carrier with a dry cotton cloth. The internal chamber and probes are not customer-accessible. If overflow is significant, contact BioTek's Technical Assistance Center.

Inspect/Clean Excitation and Emission Filters

Applies only to models with fluorescence and/or luminescence capability

BioTek recommends inspecting the filters for dust and other debris every three months. To clean them, you will need:

- Isopropyl, ethyl, or methyl alcohol
- 100% pure cotton balls or high-quality lens-cleaning tissue
- Cloth gloves
- Magnifying glass



Do not touch the filters with your bare fingers.

1. Turn off and unplug the instrument.
2. Open the access door on the front of the instrument. Slide the filter cube out of its compartment.

The **Filters and Mirrors** chapter contains illustrations for identifying the filters and their unique characteristics. It also contains instructions for replacing filters, if necessary.

3. Inspect the glass filters for speckled surfaces or a “halo” effect. This may indicate deterioration due to moisture exposure over a long period of time. If you have any concerns about the quality of the filters, contact your BioTek representative.
4. Using cotton balls or lens-cleaning tissue moistened with a small amount of high-quality alcohol, clean each filter by lightly stroking its surface in one direction. Ensure that the filters remain in their current locations.
5. Use a magnifying glass to inspect the surface; remove any loose threads left by the cotton ball.
6. Replace the filter cube and close the access door.

Inspect/Clean Mirrors

Applies only to models with fluorescence and/or luminescence capability

BioTek recommends inspecting/cleaning the mirrors and polarizing filters (if equipped) annually, especially if the filter cube has been opened or changed.



The mirrors (especially the dichroic) and polarizing filters can be easily damaged. Perform the cleaning steps only when necessary and always handle the mirror and filters carefully.

These optical elements are delicate and must be carefully handled. The glass and anti-reflective (AR) coated surfaces will be damaged by any contact, especially by abrasive particles. **In most cases, it is best to leave minor debris on the surface.** If performance indicators or obvious defects in the mirrors or filters suggest cleaning them, however, here are some guidelines:

- Use of oil-free dry air or nitrogen under moderate pressure is the best method for removing excessive debris from an optical surface. If the contamination is not dislodged by the flow of gas, please follow the cleaning instructions below.
- The purpose of the cleaning solvent is only to dissolve any adhesive contamination that is holding debris on the surface. The towel needs to absorb both the excessive solvent and entrap the debris so that it can be removed from the surface. Surface coatings on dichroics are typically less hard than the substrate. It is reasonable to expect that any cleaning will degrade the surface at an atomic level. Consideration should be given as to whether the contamination in question is more significant to the application than the damage that may result from cleaning the surface. In many cases, the AR coatings that are provided to give maximum light transmission amplify the appearance of contamination on the surface.

Materials

- 7/64" hex key
- Linen or cloth gloves
- Anhydrous reagent-grade ethanol
- Kimwipes
- Magnifying glass
- 100% pure cotton balls (for the polarizing filters)

Procedure

1. Turn off and unplug the reader.
2. Lift up the hinged door on the front of the reader. Grasp the filter cube and slide it to the right to remove it from its chamber.

ⓘ Handle with care. The mirrors are seated on a shelf in the bottom of the cube and are not secured in place.

The **Filters and Mirrors** chapter shows how to remove and open the filter cube. It also contains instructions for replacing its contents, if necessary.

3. Set the cube on a flat work surface (do not hold it in your hand). After you remove the filter cube's top in step 4, the mirrors will fall out if the cube is not on a stable, flat surface.
4. Using a 7/64" hex key, remove the screw and washer located between the two emission filter positions (shown in [Figure 4-5](#) on page 50). Carefully lift the top off the filter cube.
5. Wearing linen or cloth gloves, grasp the mirror by its edges and lift it out of the cube.
6. Wet an absorbent towel (such as a Kimwipe, not lens paper) with anhydrous reagent-grade ethanol. Wear gloves and use enough toweling so that solvents do not dissolve oils from your hands that can seep through the toweling onto the coated surface.
7. Drag the trailing edge of the ethanol-soaked Kimwipe across the surface of the mirror, moving in a single direction. A minimal amount of pressure can be applied while wiping. However, too much pressure will damage the mirror.
8. Use the magnifying glass to inspect the surface; if debris is still visible, repeat with a new Kimwipe.
9. To replace the mirror, hold it by its edges, turn it so that its label is face-up and readable, and place it on the shelf in the filter cube. See [Figure 4-3](#) on page 46.
10. Place the filter cube top back onto the cube and replace the screw and washer.
11. Reinstall the filter cube in the reader.

Flush/Purge Fluid Path

Applies only to models equipped with injectors

At the end of each day that the dispense module is in use, flush the fluid path using the Gen5 priming utility. Leave the fluid to soak overnight or over a weekend, and then purge the fluid before using the instrument again.

This flushing and purging routine is also recommended before disconnecting the outlet tubes from the reader, and before decontamination to remove any assay residue prior to applying isopropyl alcohol or sodium hypochlorite.

① If using Gen5 version 2.05 or earlier, the **Prime** and **Purge** options are found under the **Dispenser** tab in the Reader Control dialog.

To flush the fluid path:

1. Fill two supply bottles with deionized or distilled water. Insert the supply (inlet) tubes into the bottles.
2. Place the priming plate on the carrier.
3. Select **System > Instrument Control > Synergy H1**.
4. Click the **Prime** tab and select Dispenser 1.
5. Set the Volume to 5000 μL . Keep the default prime rate.
6. Click **Prime** to start the process. When the process is complete, carefully remove the priming plate from the carrier and empty it.
7. Repeat the process for Dispenser 2.

Leave the water in the system overnight or until the instrument will be used again. Purge the fluid from the system (see below) and then prime with the dispense reagent before running an assay.

To purge the fluid from the system:

1. Place the inlet tubes in empty supply bottles or a beaker.
2. Select **System > Instrument Control > Synergy H1**.
3. Click the **Prime** tab and select Dispenser 1.
4. Set the Volume to 2000 μL .
5. Click **Purge** to start the process.
6. When the purge is complete, repeat the process for Dispenser 2.

After purging the system, you may wish to run a quick Dispense protocol to visually verify the dispense accuracy (see the next section) or the more thorough Dispense Accuracy and Precision Tests (see [Injection System Tests](#) starting on page 134).

Run a Dispense Protocol (Optional)

Applies only to models equipped with injectors

After flushing/purging the system (described on page 61) and before running an assay that requires dispense, take a moment to visually inspect the dispense accuracy.



Use a DI H₂O-Tween solution to visually inspect the dispense accuracy following maintenance: e.g., add 1 mL Tween 20 to 1000 mL of deionized water.

1. Create a new protocol in Gen5. Select a Plate Type that matches the plate you are using.
2. Add a Dispense step with the following parameters:
 - Select Dispenser 1
 - Set Tip Priming to "Before this dispense step" and Volume to 10 µL
 - Set the Dispense Volume to 100 µL (or an amount to match your assay protocol)
 - Adjust the Rate to support the dispensing volume
3. Add another Dispense step with the same parameters, selecting Dispenser 2.
4. Add a quick Read step with parameters relevant to your reader model (this is necessary because Gen5 requires that a Read step follow the Dispense step).
5. Save the protocol with an identifying name, such as "Dispense Observation."
6. Fill the supply bottles with the DI H₂O-Tween solution mentioned above.
7. Create and run an experiment based on the Dispense Observation protocol.
8. When the experiment is complete, visually assess the fluid level in the wells. Well volumes should appear evenly distributed across the plate.

If the well volume appears to be unevenly distributed, clean the internal dispense tubes and injectors as described in [Clean the Dispense Tubes and Injectors](#) starting on page 63 and run the protocol again.

Empty/Clean the Tip Priming Trough

Applies only to models equipped with injectors

The tip priming trough is a removable cup located in the rear pocket of the microplate carrier, used for performing the tip prime. The trough holds about 1.5 mL of liquid and must be periodically emptied and cleaned.

1. Extend the microplate carrier and carefully remove the tip priming trough from its pocket in the left rear of the carrier.
2. Wash the trough in hot, soapy water. Use a small brush to clean in the corners.
3. Rinse the trough thoroughly and allow it to dry completely.
4. Replace the trough in the microplate carrier.

At the start of an experiment that requires dispensing, Gen5 prompts the user to empty the tip prime trough.

Clean the Priming Plate

Applies only to models equipped with injectors

Clean the priming plate regularly to prevent bacteria growth and residue buildup. Wash the plate in hot, soapy water, using a small brush to clean in the corners. Rinse thoroughly and allow it to dry completely.

Clean the Dispense Tubes and Injectors

Applies only to models equipped with injectors

The dispense tubes and injectors require routine cleaning, at least quarterly and possibly more frequently depending on the type of fluids dispensed.

Required Materials

- Protective gloves and safety glasses
- Mild detergent
- Clean, lint-free cotton cloths
- Deionized or distilled water
- Stylus (affixed to the rear of the dispense module or reader) (BTI #2872304)

Remove the Dispense Tubes and Injector Tip Holder

See [Figure 2-3](#) on page 14 for the location of the injector tip holder.

1. **Purge** the dispense lines of all fluid; see the instructions under on page 37.
2. Open the door on the front of the reader.
3. Grasp the injector tip holder by the tab and pull it up out of its socket.
4. Using your fingers, remove the thumbscrews securing the light shield to the top of the reader and slide the shield up the outlets tubes.
5. Slide the injector tip holder through the hole in the top of the reader.
6. Turn each tube's thumbscrew counterclockwise and gently pull the tube from its injector tip.
7. On the dispense module, turn each outlet tube's thumbscrew counterclockwise to disconnect it from the syringe drive.



Caution! Do not bend the injector tips! A bent tip may not dispense accurately.

Clean the Dispense Tubes and Injectors

As discussed on page 54, some reagents can crystallize and clog the tubing and injectors. Daily flushing and purging can help to prevent this, but more rigorous cleaning may be necessary if reagent has dried in the tubing or injectors.

To clean the dispense tubes, soak them in hot, soapy water to soften and dissolve any hardened particles. Flush each tube by holding it vertically under a stream of water.

To clean the injectors:

- Gently insert the stylus into each injector tip to clear any blockages. (The stylus is stored in a cylinder affixed to the rear of the dispense module.)
- Stream water through the pipe to be sure it is clean. If the water does not stream out, try soaking in hot, soapy water and then reinserting the stylus.

As-Needed Maintenance

This chapter contains maintenance and component-replacement procedures that need to be performed only occasionally.

Decontamination	66
Required Materials	66
Procedure for Models without the Dispense Module	67
Procedure for Models with the Dispense Module	68
Dispense Module, Syringe Replacement	71
Syringe Maintenance Position	71
Replace the Syringe	72



Decontamination

Any laboratory instrument that has been used for research or clinical analysis is considered a biohazard and requires decontamination prior to handling.

Decontamination minimizes the risk to all who come into contact with the instrument during shipping, handling, and servicing. Decontamination is required by the U.S. Department of Transportation regulations.

Persons performing the decontamination process must be familiar with the basic setup and operation of the instrument.

	<p>BioTek Instruments, Inc., recommends the use of the following decontamination solutions and methods based on our knowledge of the instrument and recommendations of the Centers for Disease Control and Prevention (CDC). Neither BioTek nor the CDC assumes any liability for the adequacy of these solutions and methods. Each laboratory must ensure that decontamination procedures are adequate for the biohazards they handle.</p>
---	---

	<p>Wear prophylactic gloves when handling contaminated instruments. Gloved hands should be considered contaminated at all times; keep gloved hands away from eyes, mouth, and nose. Eating and drinking while decontaminating instruments is not advised.</p>
	<p>Mucous membranes are considered prime entry routes for infectious agents. Wear eye protection and a surgical mask when there is a possibility of aerosol contamination. Intact skin is generally considered an effective barrier against infectious organisms; however, small abrasions and cuts may not always be visible. Wear protective gloves when performing the decontamination procedure.</p>

Required Materials

For all Synergy H1 models:

- Sodium hypochlorite (NaClO, or bleach)
- 70% isopropyl alcohol (as an alternative to bleach)
- Deionized or distilled water
- Safety glasses
- Surgical mask
- Protective gloves

- Lab coat
- Biohazard trash bags
- 125-mL beakers
- Clean, lint-free cotton cloths or paper towels

Additional materials for models with the dispense module:

- Screwdriver
- Small brush for cleaning the tip priming trough and priming plate
- (Optional) Mild detergent

Procedure for Models without the Dispense Module



The sodium hypochlorite (bleach) solution is caustic; wear gloves and eye protection when handling the solution.

Do not immerse the instrument, spray it with liquid, or use a dripping-wet cloth. **Do not allow the cleaning solution to run into the interior of the instrument.** If this happens, contact the BioTek Service Department.

Turn off and unplug the instrument for all decontamination and cleaning operations.

1. Turn off and unplug the instrument.
2. Prepare an aqueous solution of 0.50% sodium hypochlorite (bleach). If the effects of bleach are a concern, 70% isopropyl alcohol may be used.

Check the percent NaClO of the bleach you are using. Commercial bleach is typically 10.0% NaClO; prepare a 1:20 dilution. Household bleach is typically 5.0% NaClO; prepare a 1:10 dilution.

3. Wet a cloth or paper towel with the bleach solution or alcohol, and then **thoroughly wring it out so that liquid does not drip from it.**
4. Open the plate carrier door, and slide out the plate carrier.
5. Wipe the plate carrier and all exposed surfaces of the instrument.
6. Wait 20 minutes. Moisten a cloth with deionized (DI) or distilled water and wipe all surfaces of the instrument that have been cleaned with the bleach solution or alcohol.
7. Use a clean, dry cloth to dry all wet surfaces.
8. Reassemble the instrument as necessary.
9. Discard the used gloves and cloths using a biohazard trash bag and an approved biohazard container.

Procedure for Models with the Dispense Module

Perform the *Routine Procedure* below when the equipment is functioning normally. If you are unable to perform a prime due to a system failure, perform the *Alternate Procedure* described on page 70.

① If using Gen5 version 2.05 or earlier, the **Prime** and **Purge** options are found under the **Dispenser** tab in the Reader Control dialog.

Routine Procedure



If disinfecting with sodium hypochlorite (bleach), flush repeatedly with deionized water to remove the bleach. After disinfecting with sodium hypochlorite, perform the rinse procedure provided on page 69.

If disinfecting with alcohol, do not immediately prime with deionized water, because the drying effect of the alcohol is an important aspect of its disinfectant properties.

Clean Exposed Surfaces

1. Turn off and unplug the instrument.
2. Prepare an aqueous solution of 0.50% sodium hypochlorite (bleach). If the effects of bleach are a concern, 70% isopropyl alcohol may be used.

Check the percent NaClO of the bleach you are using. Commercial bleach is typically 10.0% NaClO; prepare a 1:20 dilution. Household bleach is typically 5.0% NaClO; prepare a 1:10 dilution.

3. Open the plate carrier door and slide out the plate carrier.
4. Wet a cloth or paper towel with the bleach solution or alcohol, and then **thoroughly wring it out so that liquid does not drip from it**.
5. Wipe the plate carrier and the exposed surfaces of the external dispense module.
6. Wait 20 minutes. Moisten a cloth with deionized (DI) or distilled water and wipe all surfaces that have been cleaned with the bleach solution or alcohol.
7. Use a clean, dry cloth to dry all wet surfaces.
8. Reassemble the instrument as necessary.
9. If the dispense module is installed, purge any fluid (see *Flush/Purge Fluid Path* on page 61) and detach the outlet tubes from the instrument. If it is not installed, attach only the dispense module's communication cable to the instrument. Remove the supply bottles and their holders.
10. Perform the decontamination procedures described below.

Decontaminate the Fluid Lines

1. Place a beaker with 20 mL of 0.5% sodium hypochlorite solution or 70% isopropyl alcohol near SYRINGE 1 on the dispense module.
2. Place the SYRINGE 1 inlet tube in the beaker.
3. If you have not already done so, detach the dispense module's outlet tubes from the instrument. Place the ends of the outlet tubes in an empty beaker and set the beaker next to the dispense module.
4. Launch Gen5, select **System > Instrument Control**, and click the **Prime** tab.
5. Select **Dispenser 1**, enter a Volume of 5000 μL , and keep the default dispense Rate.
6. Place the priming plate on the carrier.
7. Run two prime cycles, for a total of 10,000 μL .
8. Wait at least 20 minutes to allow the solution to disinfect the tubing.
9. Remove the inlet tube from the beaker of disinfectant solution.
10. From the Reader Control dialog, change the Volume to 1000 μL .
11. Run one prime cycle, to flush the disinfectant out of the fluid lines.
12. Empty the beaker containing the outlet tubes. Put the tubes back in the empty beaker.
13. If sodium hypochlorite (bleach) was used, perform the next procedure, *Rinse the Fluid Lines*.

Otherwise (or after performing the Rinse procedure), repeat steps 1–13 for SYRINGE 2/Dispenser 2.

Rinse the Fluid Lines

Perform this procedure only if decontamination was performed using sodium hypochlorite.

1. Place a beaker containing at least 30 mL of deionized water on the dispense module.
2. Place the SYRINGE 1 or 2 inlet tube in the beaker.
3. If you have not already done so, place the outlet tubes in an empty beaker.
4. From the Reader Control dialog, select Dispenser 1 or 2, set the Volume to 5000 μL , and keep the default dispense Rate.
5. Run five prime cycles, for a total of 25,000 μL .
6. Pause for 10 minutes and then run one prime cycle with 5000 μL . This delay will allow any residual sodium hypochlorite to diffuse into the solution and be flushed out with the next prime.
7. Empty the beaker containing the outlet tubes.
8. Wipe all surfaces with deionized water.

9. Discard the used gloves and cloths using a biohazard trash bag and an approved biohazard container.

Clean the Tubing and Injectors

Perform the procedures under *Clean the Dispense Tubes and Injectors* on page 63.

Decontaminate the Tip Priming Trough and Priming Plate

1. Remove the tip priming trough from the instrument's microplate carrier.
2. Wash the tip priming trough and priming plate in hot, soapy water. Use a small brush or cloth to clean the corners of the trough and plate.
3. To decontaminate, soak the trough and plate in a container of 0.5% sodium hypochlorite or 70% isopropyl alcohol for at least 20 minutes.
 - If decontaminating in a bleach solution, thoroughly rinse the trough and plate with DI water.
 - If decontaminating with alcohol, let the trough and plate air dry.
4. Discard the used gloves and cloths using a biohazard trash bag and an approved biohazard container.

Alternate Procedure

If you are unable to prime the system due to an equipment failure, decontaminate the instrument and the dispense module as follows:

1. Perform the procedures under *Clean the Dispense Tubes and Injectors* on page 63.
2. Prepare an aqueous solution of 0.50% sodium hypochlorite (bleach). If the effects of bleach are a concern, 70% isopropyl alcohol may be used.

Check the percent NaClO of the bleach you are using. Commercial bleach is typically 10.0% NaClO; prepare a 1:20 dilution. Household bleach is typically 5.0% NaClO; prepare a 1:10 dilution.

3. Slide the microplate carrier out of the instrument.
4. Wet a cloth or paper towel with the bleach solution or alcohol, and then **thoroughly wring it out so that liquid does not drip from it.**
5. Use the cloth to wipe:
 - All exterior surfaces of the instrument
 - All surfaces of the plate carrier
 - The exposed surfaces of the dispense module, including the syringe valves
6. Remove the tubing and the syringes from the dispense module and soak them in the bleach or alcohol solution. Wait for 20 minutes.

To remove a syringe: In Gen5, click **System > Instrument Control > Synergy H1**. On the Prime tab, select a dispenser and click **Maintenance**. The syringe bracket will move to its furthest-from-home position. Remove the metal thumbscrew from underneath the bracket. Unscrew the top of the syringe from the bottom of the syringe drive. Gently remove the syringe.

7. Moisten a cloth with DI or distilled water and wipe all surfaces that have been cleaned with the bleach solution or alcohol.
8. Rinse all tubing and the syringes with DI water.
9. Use a clean, dry cloth to dry all surfaces on the instrument and the dispense module.
10. Reassemble the dispense module as necessary.
11. Discard the used gloves and cloths using a biohazard trash bag and an approved biohazard container.

Dispense Module, Syringe Replacement

Refer to the **Preventive Maintenance** chapter for cleaning procedures you must perform regularly and also in the case of poor performance (for example, when the Dispense Accuracy and Precision tests fail). If cleaning the injection system does not eliminate performance problems, or if a syringe is leaking, perform these instructions to replace a faulty syringe. Contact BioTek TAC to order replacement syringes.

To change a syringe, first use Gen5 to put the syringe in its maintenance position.

Syringe Maintenance Position



Do not change the syringe position or calibrate the dispensers unless instructed to do so by BioTek as part of installation, upgrade, or maintenance.

Gen5 provides access to syringe setup functions for maintenance and calibration purposes. When a syringe needs to be installed or replaced, it must first be moved to its “maintenance position.”

1. In Gen5, select **System > Instrument Control > Synergy H1** and click the **Prime** tab (or **Dispenser** tab, if using Gen5 v2.05 or lower).
2. Select the appropriate Dispenser number (1 or 2) associated with the syringe.
3. Click **Maintenance**. The syringe plunger will move to its furthest-from-home position. The syringe can then be disconnected from the drive bracket and unscrewed from the valve.

Replace the Syringe

Refer to [Figure 2-5](#) on page 16.

After using Gen5 to move the syringe into its maintenance position:

1. Using your fingers, unscrew the bottom thumbscrew that secures the syringe, underneath the bracket. Retain this bottom thumbscrew; it is needed for the replacement syringe.
2. Unscrew the top thumbscrew to disengage the syringe from the valve.
3. Remove the new syringe from its protective box.
4. Hold the syringe vertically with the threaded end at the top. Screw the top of the syringe into the bottom of the syringe valve. Finger-tighten only.
5. Carefully pull down the bottom of the syringe until it rests inside the hole in the bracket.
6. Pass the thumbscrew (used to hold the old syringe) up through this hole and thread it into the bottom of the syringe. Hold the syringe from rotating while tightening the thumbscrew. Finger-tighten only.
7. In Gen5, select **System > Instrument Control > Synergy H1**.
8. Click the **Prime** tab and click **Initialize**.

Instrument Qualification Process

This chapter describes the tests that BioTek Instruments, Inc. has developed for complete qualification of all models of the Synergy H1. This chapter introduces the various test methods, describes the materials and relevant Gen5 protocols used to execute the tests, explains how to analyze test results, and provides troubleshooting tips in the event of a failure.

Instrument Qualification Procedures starting on page 107 contains the actual step-by-step test procedures.

Instrument System Test	74
Plate Shaker Test	74
Absorbance Testing	75
Luminescence Testing	83
Fluorescence Testing	87
Injection System Testing	102

Instrument System Test

Each time the Synergy H1 is turned on, it automatically performs a series of tests on the reader's motors, lamp(s), the PMT, and various sub-systems. The duration of this "system test" depends on the reader model and can take a few minutes to complete. If all tests pass, the microplate carrier will eject and the LED on the power switch will remain on and constant. The reader is then ready for use.

If any test results do not meet the internally coded Failure Mode Effects Analysis (FMEA) criteria established by BioTek, the reader will beep repeatedly and the LED on the power switch will flash. If this occurs, press the carrier eject button to stop the beeping. If necessary, initiate another system test using Gen5 to try to retrieve an error code from the reader.

Refer to **Error Codes** starting on page 145 for information on error codes and troubleshooting tips.

Refer to **Sample Reports** on page 155 to see a sample System Test Report for Synergy H1.

Plate Shaker Test

This test verifies that the multi-speed plate shaker is operating properly. The test involves creating and running a protocol with shaking enabled for a duration of 30 seconds. The sound of the carrier shaking is all that needs to be confirmed to verify that the plate shaker is operating properly.

Absorbance Testing

For models with absorbance capability, BioTek developed a series of tests for the absorbance system using a combination of solid state Absorbance Test Plates and liquid plates. The test plates and the materials used for creating the liquid plates are available for purchase from BioTek.

To qualify the absorbance system for the Synergy H1, you should perform:

- Absorbance Liquid Test 1 *and* Absorbance Plate Test (using BTI #7260522) *or*
- Absorbance Liquid Test 2

Optionally, to qualify operation in the UV range, you should also perform:

- Absorbance Liquid Test 3 *or* Absorbance Plate Test at 340 nm (using BTI #7260551)

BioTek Absorbance Test Plates

Absorbance Test Plate PN 7260522 uses NIST-traceable neutral density filters to confirm absorbance specifications in the visible range (400–800 nm). This test plate also contains precision-machined holes to verify mechanical alignment, and a glass filter in position C6 to test the wavelength accuracy of the monochromator-based absorbance system.

Absorbance Test Plate PN 7260551 uses NIST-traceable neutral density filters to confirm absorbance specifications in the UV range (340 nm).

Every test plate comes with a Test Plate Calibration Certificate, containing a table with Absorbance OD Standards for each filter at each wavelength supported by the plate. The certificate for test plate PN 7260522 also contains Wavelength Accuracy Standards tables with Expected Peak (nm) values with Test Ranges for the C6 glass filter.

Before the Absorbance Plate Test can be performed, the OD Standard values and Expected Peak/Test Range combinations must be entered into Gen5. Enter and save these values once initially, and then update them annually when the test plate is recertified by BioTek.

Test Methods

The Absorbance Plate Test is conducted using Gen5 software (System > Diagnostics > Test Plates) to confirm wavelength accuracy ("Peak Absorbance"); mechanical alignment; and optical density accuracy, linearity, and repeatability. When complete, Gen5 generates a results report displaying Pass or Fail for each individual test.

- **Peak Absorbance:** The BTI #7260522 test plate contains a glass filter in position C6 that is used to check the wavelength accuracy of the absorbance monochromator. The filter is scanned across a specified wavelength range in 1-nm increments. The wavelength(s) of maximum absorbance are compared to the expected peak wavelength(s) supplied on the test plate's data sheet. The accuracy of the wavelength should be ± 3 nm (± 2 nm instrument, ± 1 nm filter allowance).

- **Alignment:** The test plate has precisely machined holes to confirm mechanical alignment. The amount of light that shines through these holes is an indication of whether the microplate carrier is properly aligned with the absorbance optical path. A reading of more than 0.015 OD for any of the designated alignment holes indicates that the light is being “clipped” and the reader may be out of alignment.
- **Accuracy:** The test plate contains NIST-traceable neutral-density glass filters of known OD values at one or more wavelengths. Actual measurements are compared against the expected values provided in the test plate’s data sheet. Since there are several filters with differing OD values, the accuracy across a range of ODs can be established. Once it is proven that the reader is accurate at these OD values, the reader is also considered to be linear. To further verify this, you can perform a linear regression analysis on the test plate OD values in a program such as Microsoft Excel; an R^2 value of at least 0.9900 is expected.
- **Repeatability:** This test ensures the instrument meets its repeatability specification by conducting repeated reads of each neutral-density filter on the test plate and comparing the results.

Sample Test Report

Refer to [Sample Reports](#) on page 155 to see a sample Absorbance Plate Test Report for Synergy H1.

Troubleshooting

If a test fails, try the troubleshooting tips below. If the test continues to fail, contact BioTek TAC.



Important! Do not remove filters from the Absorbance Test Plate. Do not use alcohol or other cleaning agents, and do not touch the filters with your bare fingers.



If a higher-OD well reports "#N/A" for Min/Max Limit and Result, the measured OD is beyond the specified range for Accuracy or Repeatability used with this test, and therefore no pass/fail determination is made. It does not indicate a test failure.

Peak Absorbance Test

- Check the filter in the C6 position to ensure it is clean. If needed, clean the filter with lens paper. Do not remove the filter, and do not use alcohol or other cleaning agents.
- Verify that the Peak wavelength information entered for the plate in Gen5 matches the information provided on the test plate's data sheet.
- Check the calibration due date on the test plate's label. If the test plate is overdue for

recalibration, contact BioTek to schedule service.

- Check the microplate carrier to ensure it is clear of debris.

Alignment Test

- Ensure that the test plate is properly seated in the microplate carrier.
- Check the four alignment holes (A1, A12, H1, H12) to ensure they are clear of debris.
- Check the microplate carrier to ensure it is clear of debris.

Accuracy Test

- Check the neutral-density filters to ensure they clean (positions C1, D4, E2, F5, G3, H6). If needed, clean the filters with lens paper. Do not remove any filters, and do not use alcohol or other cleaning agents.
- Verify that the wavelength/expected OD values entered for the plate in Gen5 match the information provided on the test plate's data sheet.
- Check the calibration due date on the test plate's label. If the test plate is overdue for recalibration, contact BioTek to schedule service.

Repeatability Test

- Check the neutral-density filters to ensure there is no debris that may have shifted between readings and caused changes.
- Check the microplate carrier to ensure it is clear of debris.

Absorbance Liquid Tests

BioTek Instruments, Inc. has developed a series of liquid test procedures for testing your reader's absorbance system.

Test Methods

Absorbance Liquid Test 1 confirms repeatability and alignment of the reader when a solution is used in the microplate. If these tests pass, then the lens placement and optical system cleanliness are proven. For the Repeatability portion of this test, two columns containing a color-absorbing solution are read five times at 405 nm. For each well, an "allowed deviation" is determined based on its Mean OD and the reader's repeatability specification. Each well's Standard Deviation must be less than its Allowed Deviation to pass. To confirm the reader's mechanical alignment, the plate is rotated 180 degrees in the carrier (e.g., A1 is now in the H12 position) and the same two columns are read. The initial and new OD readings are compared, using the reader's accuracy specification. If the two readings in the same well do not meet specification, the reader may be out of alignment.

If an Absorbance Test Plate is not available, **Absorbance Liquid Test 2** may be conducted to test the instrument's alignment, repeatability, and accuracy by preparing a series of solutions of varying OD values as described on page 116.

Absorbance Liquid Test 3 is an optional test offered for those sites that must have proof of linearity at 340 nm. (Alternatively, the BioTek 340 nm Absorbance Test Plate may be used; see page 75.) This test is optional since the Synergy H1 has good “front-end” linearity throughout the specified wavelength range. While the absolute values of the OD cannot be determined by this test, the results will indicate if there is adequate repeatable absorbance and a linear slope. This method is dependent upon proper dye dilution and a skilled pipetting technique. It is expected that the first dilution (mid-level solution) will have an absorbance value near 75% of that of the stock (high-level) solution, and that the second dilution (low-level solution) will have an absorbance value near 50% of that of the stock solution.

Gen5 Protocol Parameters

The information in this section represents the recommended reading parameters for the referenced Gen5 protocol(s). It is possible that your tests will require modifications to some of these parameters, such as the Plate Type.

① The Plate Type setting in each Gen5 protocol should match the actual plate in use.

Synergy H1 Abs Test 1.prt

Parameter	Setting
Plate Type	96 WELL PLATE
Shake Step	Linear, 4 minutes, default frequency
Two Read Steps	
Kinetic loop (one per Read step)	Set a Run Time/Interval combination to read the plate five times with minimal delay
Detection Method	Absorbance
Read Type	Endpoint
Optics Type	Monochromators
Read wells	First Read step: A1..H2 Second Read step: A11..H12
Wavelength	405 nm
Read Speed	Normal
Delay after plate movement	100 msec
Plate Out,In step between loops	Text "rotate the plate 180 degrees"

Synergy H1 Abs Test 2.prt

Parameter	Setting
Plate Type	96 WELL PLATE
Shake Step	Linear, 4 minutes, default frequency
Two Read Steps	
Kinetic loop (one per Read step)	Set a Run Time/Interval combination to read the plate five times with minimal delay
Detection Method	Absorbance
Read Type	Endpoint
Optics Type	Monochromators
Step labels	First Read step: "Normal" Second Read step: "Turnaround"
Read wells	Full plate
Wavelengths	2 (450 nm, 630 nm)
Read Speed	Normal
Delay after plate movement	100 msec
<i>Data Reduction</i>	Define two Delta OD transformations (450-630 nm), one per Read data set

Synergy H1 Abs Test 3.prt

Parameter	Setting
Plate Type	96 WELL PLATE
Shake Step	Linear, 30 seconds, default frequency
Kinetic loop	Set a Run Time/Interval combination to read the plate five times with minimal delay
Detection Method	Absorbance
Read Type	Endpoint
Optics Type	Monochromators
Read wells	A1..H6
Wavelength	340 nm
Read Speed	Normal
Delay after plate movement	100 msec

Results Analysis

The Absorbance Liquid Test procedures begin on page [114](#).

Absorbance specifications used with the liquid tests:

Accuracy:

- ± 1.0% ± 0.010 OD from 0.000 to 2.000 OD
- ± 3.0% ± 0.010 OD from 2.000 OD to 2.500 OD

Repeatability:

- ± 1.0% ± 0.005 OD from 0.000 to 2.000 OD
- ± 3.0% ± 0.005 OD from 2.000 OD to 2.500 OD

Absorbance Liquid Test 1

1. The plate is read five times in the "Normal" position at 405 nm. Calculate the Mean OD and Standard Deviation of those five reads for each well in columns 1 and 2.
2. For each well in columns 1 and 2, calculate the Allowed Deviation using the Repeatability specification for a 96-well plate (Mean OD x 0.010 + 0.005). For each well, its Standard Deviation should be less than its Allowed Deviation.

Example: Five readings in well A1 of 0.802, 0.802, 0.799, 0.798, and 0.801 result in a Mean of 0.8004 and a Standard Deviation of 0.0018. The Mean multiplied by 1.0% (0.8004×0.010) equals 0.008, and when added to 0.005 equals 0.013; this is the Allowed Deviation for well A1. Since the Standard Deviation for well A1 is less than 0.013, the well meets the test criteria.

3. The plate is read five times in the "Turnaround" position at 405 nm. Calculate the Mean OD of those five reads for each well in columns 11 and 12.
4. Perform a mathematical comparison of the Mean values for each well in its Normal and Turnaround positions (that is, compare A1 to H12, A2 to H11, B1 to G12,... H2 to A11). To pass the test, the differences in the compared Mean values must be within the Accuracy specification for a 96-well microplate.

Example: If the Mean value for well A1 in the Normal position is 1.902 with a specified accuracy of $\pm 1.0\% \pm 0.010$ OD, then the expected range for the Mean of the well in its Turnaround (H12) position is 1.873 to 1.931 OD. $1.902 \times 0.010 + 0.010 = 0.029$; $1.902 - 0.029 = 1.873$; $1.902 + 0.029 = 1.931$.

Absorbance Liquid Test 2

1. The plate is read five times at 450/630 nm ("Normal" position), resulting in five sets of Delta OD data. Calculate results for Linearity:
 - Calculate the mean absorbance for each well, and average the means for each concentration.
 - Perform a regression analysis on the data to determine if there is adequate linearity. Since it is somewhat difficult to achieve high pipetting accuracy when

conducting linear dilutions, an R^2 value of at least 0.9900 is considered adequate.

2. Calculate the results for Repeatability:

- Calculate the Mean and Standard Deviation for the five readings taken at each concentration. Only one row of data needs to be analyzed.
- For each Mean below 2.000 OD, calculate the Allowed Deviation using the Repeatability specification for a 96-well plate of $\pm 1.0\% \pm 0.005$ OD. (If above 2.000 OD, apply the $\pm 3.0\% \pm 0.005$ specification.)
- The Standard Deviation for each set of readings should be less than the Allowed Deviation.

Example: Readings of 1.950, 1.948, 1.955, 1.952, and 1.950 will result in a Mean of 1.951, and a Standard Deviation of 0.0026. The Mean (1.951) multiplied by 1.0% (1.951×0.010) = 0.0195, which, when added to the 0.005 ($0.0195 + 0.005$) = 0.0245 OD, which is the Allowed Deviation. Since the Standard Deviation is less than this value, the reader meets the test criteria.

3. After gathering data for the Linearity Test, the plate is read five more times with the A1 well in the H12 position ("Turnaround" position). This results in values for the four corner wells that can be used to assess alignment. Calculate results for the Alignment Test:

- Calculate the means of the wells A1 and H1 in the Normal plate position (data from Linearity Test) and in the Turnaround position.
- Compare the mean reading for well A1 to its mean reading when in the H12 position. Next, compare the mean values for the H1 well to the same well in the A12 position. The difference in the values for any two corresponding wells should be within the Accuracy specification for 96-well plates. If the four corner wells are within the accuracy range, the reader is in alignment.

Example: If the mean of well A1 in the normal position is 1.902, where the specified accuracy is $\pm 1.0\% \pm 0.010$ OD, then the expected range for the mean of the same well in the H12 position is 1.873 to 1.931 OD. ($1.902 \times 1.0\% = 0.019 + 0.010 = 0.029$, which is added to and subtracted from 1.902 for the range.)

Absorbance Liquid Test 3

1. The plate is read five times at 340 nm. For each well, calculate the Mean OD and Standard Deviation of the five readings.
2. For each Mean calculated in step 1, calculate the Allowed Deviation using the Repeatability specification for a 96-well plate (Mean OD $\times 0.010 + 0.005$). For each well, its Standard Deviation should be less than its Allowed Deviation.

Example: Five readings in well A1 of 0.802, 0.802, 0.799, 0.798, and 0.801 result in a Mean of 0.8004 and a Standard Deviation of 0.0018. The Mean multiplied by 1.0% (0.8004×0.010) equals 0.008, and when added to 0.005 equals 0.013; this is

the Allowed Deviation for well A1. Since the Standard Deviation for well A1 is less than 0.013, the well meets the test criteria.

3. Calculate results for Linearity:
 - For each of the three test solutions, calculate the average Mean OD for the wells containing that solution (mean of wells A1 to H2, A3 to H4, and A5 to H6).
 - Perform a regression analysis on the data to determine if there is adequate linearity. The three average Mean OD values are the "Y" values. The solution concentrations are the "X" values (1.00, 0.75, 0.50). Since it is somewhat difficult to achieve high pipetting accuracy when conducting linear dilutions, an R^2 value of at least 0.9900 is considered adequate.

Troubleshooting

If an absorbance liquid test fails, try the following. If a test continues to fail, contact BioTek TAC.

- Check the microwells and plate carrier for debris that may have shifted and caused changes.
- Ensure the microplate is properly seated in the carrier.
- As applicable, confirm that the plate was properly oriented in the "Normal" and "Turnaround" positions.
- Liquid Test 1 can fail due to the meniscus effect, which can cause readings to decrease over time. If you suspect this may be the case, include a shake step between the read steps in the protocol.

Luminescence Testing

For models with luminescence capability, BioTek uses the Harta Luminometer Reference Microplate to test the luminescence system. The test plate is LED-based and NIST-traceable. Contact BioTek to purchase a plate (BTI #8030015; includes microplate carrier adapters) or visit www.HartaInstruments.com to learn more.

Test Method

The Harta Luminometer Reference Microplate is used to determine a detection limit by leveraging a known correlation of 35 photons per attomole of ATP. By using the NIST data provided with the Harta plate in photons/s, a conversion factor of 0.02884 attomole/photon is applied to determine an ATP concentration and subsequent limit of detection for the instrument under test.

Gen5 Protocol Parameters

The information in this section represents the recommended reading parameters for the referenced Gen5 protocol(s).

Synergy H1 F-LumTest_Harta.prt

Parameter	Setting
Plate Type	If present "8030015 Harta - w/o 8032028 adapter" otherwise "Costar 96 black opaque"
Delay Step	3 minutes
READ STEP 1	
Detection Method	Luminescence
Read Type	Endpoint
Optics Type	Filters
Step Label	Reference well A2
Read well	A2
Filter Set	1 (filter cube)
Excitation	Plug
Emission	Hole
Gain	135
Integration Time	0:10.00 MM:SS.ss
Delay After Plate Movement	350 msec
Dynamic Range	Standard
Read Height	7.00 mm

Parameter	Setting
READ STEP 2	
Detection Method	Luminescence
Read Type	Endpoint
Optics Type	Filters
Step Label	Background
Read wells	D1–G4
Filter Set	1 (filter cube)
Excitation	Plug
Emission	Hole
Gain	135
Integration Time	0:10.00 MM:SS.ss
Delay After Plate Movement	350 msec
Dynamic Range	Standard
Read Height	7.00 mm
READ STEP 3	
Detection Method	Luminescence
Read Type	Endpoint
Optics Type	Filters
Step Label	Battery check
Read wells	A7–A8
Filter Set	1 (filter cube)
Excitation	Plug
Emission	Hole
Gain	60
Integration Time	0:01.00 MM:SS.ss
Delay After Plate Movement	350 msec
Dynamic Range	Extended
Read Height	10.00 mm

Synergy H1 M-LumTest_Harta.prt

The same as the filter-based test, with these exceptions:

Parameter	Setting
READ STEP 1	
Optics Type	Luminescence Fiber
Filter Set	<none>
Gain	150
Read Height	1.00 mm
READ STEP 2	
Optics Type	Luminescence Fiber
Read wells	F1-G12
Filter Set	<none>
Gain	150
Read Height	1.00 mm
READ STEP 3	
Optics Type	Luminescence Fiber
Filter Set	<none>
Gain	80
Read Height	1.00 mm

Results Analysis

The Luminescence Test procedure is described on page [119](#).

1. Determine if the plate's battery is functioning properly. If $A8 > (0.2 * A7)$, the battery is good. Otherwise, it requires replacement.

A replacement battery is included with each new and recalibrated Harta Luminometer Reference Microplate.

2. On the Harta plate's calibration certificate, locate the NIST measurement for the A2 position. Convert it to **attomoles**: $(A2 \text{ NIST measurement} * 0.02884)$
3. Calculate the **signal-to-noise ratio**: $(A2 - \text{Mean of the buffer cells}) / (3 * \text{Standard deviation of buffer cells})$
4. Calculate the **detection limit**: $A2 \text{ NIST measurement in attomoles} / \text{signal-to-noise ratio}$

Pass/Fail Criteria

- If the reader is equipped with the low-noise PMT, the detection limit must be ≤ 75 amol to pass.
- If the reader is equipped with the red-shifted PMT, the detection limit must be ≤ 500 amol to pass.

If you do not know which PMT is installed (#49984=low-noise PMT; #49721=red-shifted PMT), please contact BioTek TAC.

Troubleshooting

If a test fails, try the suggestions below. If a test continues to fail, contact BioTek's Technical Assistance Center (TAC).

- Ensure that the reading is performed through a hole in the filter cube, not through a glass filter.
- Verify that the filter cube definition in Gen5 matches the physical item.
- The optical probe(s) *may* need to be cleaned; contact BioTek TAC for guidance.

Fluorescence Testing

For models with fluorescence capability, BioTek provides two options for testing the fluorescence system. One uses a solid state Fluorescence Test Plate (package BTI# 1400006*; contact BioTek Customer Care regarding availability). The other uses liquid plates, the materials for which are available for purchase from BioTek (see [Materials for Conducting Liquid Tests](#) on page 5).

**Fluorescence Test Plate BTI# 7092092 cannot be used for these tests.*

BioTek Fluorescence Test Plate

The Fluorescence Test Plate simplifies the process for conducting fluorescence intensity, fluorescence polarization, and time-resolved fluorescence qualification tests on the Synergy H1. The test plate is solid and therefore immune to the pipetting errors, evaporation issues, and costs experienced with conventional Liquid Tests.

The test plate package includes Gen5 protocols* designed specifically for use with the test plate. The protocols include embedded Microsoft Excel spreadsheets to automatically calculate results and determine pass/fail. The protocols and their spreadsheets were fully validated in accordance with BioTek Instruments' Product Validation policies and procedures. **Gen5 version 2.06 or higher is required.*

The package also contains a User Guide that describes the test methods, helps you get started with using the plate, and provides important information for cleaning and maintaining the test plate. The guide also provides troubleshooting tips and information on the annual recalibration program.

Results Analysis

Refer to the *Fluorescence Test Plate User Guide* for descriptions of the data reduction calculations for each test. The tests must meet the following criteria to pass:

Corners Test	%CV < 3.0
Sensitivity Tests:	
<i>Filters, Top, SF</i>	Detection Limit <= 10 pM
<i>Monochromators, Top, SF</i>	Detection Limit <= 20 pM
<i>Monochromators, Bottom, SF</i>	Detection Limit <= 20 pM
<i>Filters, Top, MUB</i>	Detection Limit <= 160 pg/mL
<i>Monochromators, Top, MUB</i>	Detection Limit <= 160 pg/mL
<i>Monochromators, Bottom, MUB</i>	Detection Limit <= 160 pg/mL
Linearity Test	$R^2 \geq 0.9500$ confirms that the system is linear
Time-Resolved Fluorescence (TRF) Test	Detection Limit <= 250 fM
Fluorescence Polarization (FP) Test	Mean PHPR > 340 mP, STD PLPR < 5 mP

Fluorescence Liquid Tests

Test Methods

- **Corners:** The Corners Test uses fluorescent compounds to verify that the plate carrier is properly aligned in relation to the fluorescence probe(s). This test may be conducted using either the top or bottom optics (as supported by your reader model).
- **Fluorescence Intensity (Sensitivity):** The Sensitivity Test measures a fluorescent compound (Sodium Fluorescein or Methylumbelliferone) and buffer solution to test the fluorescence reading capability of the instrument. The ability to detect specific compounds at the required limit of detection ensures that the filters, optical path, and PMT are all in working order. This test establishes the detection limit of the instrument, which is described as the lowest concentration that will create a signal that is statistically distinguishable from the buffer well. This test may be conducted using either the top or bottom optics (as supported by your reader model).
- **Linearity:** The Linearity Test verifies that the system is linear, that is, signal changes proportionally with changes in concentration.
- **Fluorescence Polarization:** The optional FP Test measures high- and low-polarized samples to verify the instrument's ability to measure polarization of a liquid fluorophore and confirm that the excitation and emission polarizers are properly oriented in the instrument. This test is conducted using only the top optics.
- **Time-Resolved Fluorescence:** The optional TRF Test measures a fluorescent compound (Europium) and buffer solution to test the time-resolved fluorescence reading capability of the instrument. The ability to detect specific compounds at the required limit of detection ensures that the filters, optical path, and PMT are all in working order. This test establishes the detection limit of the instrument, which is described as the lowest concentration that will create a signal that is statistically distinguishable from the buffer well. This test is conducted using only the top optics.

Gen5 Protocol Parameters

The information in this section represents the recommended reading parameters for the Gen5 protocols used with liquid testing. It is possible that your tests will require modifications to some of these parameters, such as the Plate Type.

① The Plate Type setting in each Gen5 protocol should match the actual plate in use.

Synergy H1 FI_T_SF.prt

Parameter	Setting
Plate Type	"Costar 96 black opaque" (#3915)
Read Step 1	
Kinetic loop	Run time 0:01:00, Interval 0:00:04 (16 reads)
Detection Method	Fluorescence intensity
Read Type	Endpoint / Kinetic
Optics Type	Filters
Step Label	"Sensitivity Read"
Read well	D7
Filter Set	1 ("Green")
Excitation	485/20 nm
Emission	528/20 nm
Optics Position	Top 510 nm
Gain	Auto, Scale to High Wells, D7, 50000
Read Speed	Normal
Delay after plate movement	350 msec
Measurements per data point	40
Lamp Energy	Low (faster)
Read Height	7.00 mm
Read Step 2	
Kinetic loop	Run time 0:01:30, Interval 0:00:06 (16 reads)
Detection Method	Fluorescence intensity
Read Type	Endpoint / Kinetic
Optics Type	Filters
Step Label	"Sensitivity Read Buffer"
Read well	C9, D9, E9
Filter Set	1 ("Green")
Excitation	485/20 nm
Emission	528/20 nm
Optics Position	Top 510 nm
Gain	Auto, Use first filter set gain from FIRST read step
Read Speed	Normal
Delay after plate movement	350 msec

Measurements per data point	40
Lamp Energy	Low (faster)
Read Height	7.00 mm
Read Step 3	
Detection Method	Fluorescence intensity
Read Type	Endpoint / Kinetic
Optics Type	Filters
Step Label	"Corners Read"
Read well	Full Plate (to support Gen5 v1.11)
Filter Set	1 ("Green")
Excitation	485/20 nm
Emission	528/20 nm
Optics Position	Top 510 nm
Gain	Auto, Scale to High Wells, A3, 50000
Read Speed	Normal
Delay after plate movement	350 msec
Measurements per data point	40
Lamp Energy	Low (faster)
Read Height	7.00 mm
Read Step 4	
Detection Method	Fluorescence intensity
Read Type	Endpoint / Kinetic
Optics Type	Filters
Step Label	"Linearity Read"
Read well	C1-F5
Filter Set	1 ("Green")
Excitation	485/20 nm
Emission	528/20 nm
Optics Position	Top 510 nm
Gain	Auto, Scale to High Wells, C1, 50000
Read Speed	Normal
Delay after plate movement	350 msec
Measurements per data point	40
Lamp Energy	Low (faster)
Read Height	7.00 mm

Synergy H1 M_FI_T_SF.prt and Synergy H1 M_FI_B_SF.prt

Parameter	Setting
Plate Type	"Costar 96 black opaque" (Top) "Greiner SensoPlate" (#655892) (Bottom)
Read Step 1	
Kinetic loop	Run time 0:01:00, Interval 0:00:04 (16 reads)
Detection Method	Fluorescence
Read Type	Endpoint / Kinetic
Optics Type	Monochromators
Step Label	"Sensitivity Read"
Read Well	D7
Wavelengths	1
Excitation	485 nm
Emission	528 nm
Optics Position	Top (or Bottom)
Gain	Auto, Scale to High Wells, D7, 50000
Read Speed	Normal
Delay after plate movement	350 msec
Measurements per data point	100
Lamp Energy	Low (faster)
Read Height	7.00 mm (Top only)
Read Step 2	
Kinetic loop	Run time 0:01:30, Interval 0:00:06 (16 reads)
Detection Method	Fluorescence
Read Type	Endpoint / Kinetic
Optics Type	Monochromators
Step Label	"Sensitivity Read Buffer"
Read Well	C9, D9, E9
Wavelengths	1
Excitation	485 nm
Emission	528 nm
Optics Position	Top (or Bottom)
Gain	Auto, Use first filter set gain from FIRST Read Step
Read Speed	Normal
Delay after plate movement	350 msec

Parameter	Setting
Measurements per data point	100
Lamp Energy	Low (faster)
Read Height	7.00 mm (Top only)
Read Step 3	
Detection Method	Fluorescence intensity
Read Type	Endpoint / Kinetic
Optics Type	Filters
Step Label	"Corners Read"
Read well	Full Plate (to support Gen5 v1.11)
Filter Set	1 ("Green")
Excitation	485 nm
Emission	528 nm
Optics Position	Top (or Bottom)
Gain	Auto, Scale to High Wells, A3, 50000
Read Speed	Normal
Delay after plate movement	350 msec
Measurements per data point	100
Lamp Energy	Low (faster)
Read Height	7.00 mm (Top only)
Read Step 4	
Detection Method	Fluorescence intensity
Read Type	Endpoint / Kinetic
Optics Type	Filters
Step Label	"Linearity Read"
Read well	C1-F5
Filter Set	1 ("Green")
Excitation	485 nm
Emission	528 nm
Optics Position	Top (or Bottom)
Gain	Auto, Scale to High Wells, C1, 50000
Read Speed	Normal
Delay after plate movement	350 msec
Measurements per data point	100
Lamp Energy	Low (faster)

Parameter	Setting
Read Height	7.00 mm (Top only)

Synergy H1 FP.prt

Parameter	Setting
Plate Type	"Costar 96 black opaque" (#3915)
Synchronized Mode	Plate mode with timing control
Detection Method	Fluorescence polarization
Read Type	Endpoint / Kinetic
Optics Type	Filters
Read wells	A6-H8
Filter Set	1 ("FP")
Excitation	485/20 nm
Emission	528/20 nm
Optics Position	Top 510 nm
Gain	Auto, Scale to High Wells, A8, 10000
Read Speed	Normal
Delay after plate movement	350 msec
Measurements per data point	60
Lamp Energy	Low (faster)
Read Height	7.00 mm

Synergy H1 TRF.prt

Parameter	Setting
Plate Type	"Costar 96 white opaque" (#3912)
Delay Step	3 minutes
Shake Step	Linear, 30 seconds, default frequency
Read Step 1	
Kinetic loop	Run time 0:00:30, Interval 0:00:02 (16 reads)
Detection Method	Time-resolved fluorescence
Read Type	Endpoint / Kinetic
Optics Type	Filters
Step Label	"Sensitivity Read"
Read well	A8
Filter Set	1 ("TRF")

Parameter	Setting
Excitation	360/40 nm
Emission	620/40 nm
Optics Position	Top 400 nm
Gain	Auto, Scale to High Wells, A8, 50000
Read Speed	Normal
Delay after plate movement	350 msec
Measurements per data point	20
Lamp Energy	Low (faster)
Delay before collecting data	300 µsec
Data collection time	1000 µsec
Read Height	7.00 mm
Read Step 2	
Kinetic loop	Run time 0:00:45, Interval 0:00:03 (16 reads)
Detection Method	Time-resolved fluorescence
Read Type	Endpoint / Kinetic
Optics Type	Filters
Step Label	"Sensitivity Read Buffer"
Read well	A6, B6, C6
Filter Set	1 ("TRF")
Excitation	360/40 nm
Emission	620/40 nm
Optics Position	Top 400 nm
Gain	Auto, Use first filter set sensitivity from FIRST Read Step
Read Speed	Normal
Delay after plate movement	350 msec
Measurements per data point	20
Lamp Energy	Low (faster)
Delay before collecting data	300 µsec
Data collection time	1000 µsec
Read Height	7.00 mm

Synergy H1 FI_T_MUB.prt

Parameter	Setting
Plate Type	"Costar 96 black opaque" (#3915)
Read Step 1	
Kinetic loop	Run time 0:01:00, Interval 0:00:04 (16 reads)
Detection Method	Fluorescence intensity
Read Type	Endpoint / Kinetic
Optics Type	Filters
Step Label	"Sensitivity Read"
Read well	D7
Filter Set	1 ("Blue")
Excitation	360/40 nm
Emission	460/40 nm
Optics Position	Top 400 nm
Gain	Auto, Scale to High Wells, D7, 80000
Read Speed	Normal
Delay after plate movement	350 msec
Measurements per data point	40
Lamp Energy	Low (faster)
Read Height	7.00 mm
Read Step 2	
Kinetic loop	Run time 0:01:30, Interval 0:00:06 (16 reads)
Detection Method	Fluorescence intensity
Read Type	Endpoint / Kinetic
Optics Type	Filters
Step Label	"Sensitivity Read Buffer"
Read well	C9, D9, E9
Filter Set	1 ("Blue")
Excitation	360/40 nm
Emission	460/40 nm
Optics Position	Top 400 nm
Gain	Auto, Use first filter set gain from FIRST Read Step
Read Speed	Normal
Delay after plate movement	350 msec

Parameter	Setting
Measurements per data point	40
Lamp Energy	Low (faster)
Read Height	7.00 mm
Read Step 3	
Detection Method	Fluorescence intensity
Read Type	Endpoint / Kinetic
Optics Type	Filters
Step Label	"Linearity Read"
Read well	C1-F5
Filter Set	1 ("Blue")
Excitation	360/40 nm
Emission	460/40 nm
Optics Position	Top 400 nm
Gain	Auto, Scale to High Wells, C1, 80000
Read Speed	Normal
Delay after plate movement	350 msec
Measurements per data point	40
Lamp Energy	Low (faster)
Read Height	7.00 mm

Synergy H1 M_FI_T_MUB.prt

Parameter	Setting
Plate Type	"Costar 96 black opaque" (#3915)
Read Step 1	
Kinetic loop	Run time 0:01:00, Interval 0:00:04 (16 reads)
Detection Method	Fluorescence intensity
Read Type	Endpoint / Kinetic
Optics Type	Monochromators
Step Label	"Sensitivity Read"
Read well	D7
Filter Set	1
Excitation	360 nm
Emission	460 nm
Optics Position	Top

Parameter	Setting
Gain	Auto, Scale to High Wells, D7, 80000
Read Speed	Normal
Delay after plate movement	350 msec
Measurements per data point	100
Lamp Energy	Low (faster)
Read Height	7.00 mm
Read Step 2	
Kinetic loop	Run time 0:01:30, Interval 0:00:06 (16 reads)
Detection Method	Fluorescence intensity
Read Type	Endpoint / Kinetic
Optics Type	Monochromators
Step Label	"Sensitivity Read Buffer"
Read well	C9, D9, E9
Filter Set	1
Excitation	360 nm
Emission	460 nm
Optics Position	Top
Gain	Auto, Use first filter set gain from FIRST Read Step
Read Speed	Normal
Delay after plate movement	350 msec
Measurements per data point	100
Lamp Energy	Low (faster)
Read Height	7.00 mm
Read Step 3	
Detection Method	Fluorescence intensity
Read Type	Endpoint / Kinetic
Optics Type	Filters
Step Label	"Linearity Read"
Read well	C1-F5
Filter Set	1
Excitation	360 nm
Emission	460 nm
Optics Position	Top

Parameter	Setting
Gain	Auto, Scale to High Wells, C1, 80000
Read Speed	Normal
Delay after plate movement	350 msec
Measurements per data point	100
Lamp Energy	Low (faster)
Read Height	7.00 mm

Results Analysis

The Fluorescence Liquid Test procedures begin on page [121](#).

Corners Test

1. Calculate the Mean of the 12 "corner" wells (A1–A3, A10–A12, H1–H3, and H10–H12).
2. Calculate the Standard Deviation of the same 12 wells.
3. Calculate the %CV: (Standard Deviation/Mean)*100

The %CV must be **<3.0** to pass.

Sensitivity Test

1. Calculate the Mean and Standard Deviation of the 16 reads for each of the buffer wells (C9, D9, E9).
2. Among the three buffer wells, find the Median Standard Deviation and corresponding Mean.
3. Calculate the Mean for the 16 reads of the SF (or MUB) Concentration well (D7).
4. Calculate the Signal-to-Noise Ratio (SNR) using the Mean SF (or MUB) Concentration, Buffer Median STD with its corresponding Buffer Mean:

$$(\langle \text{SF or MUB} \rangle \text{Mean} - \text{BufferMean}) / (3 * \text{BufferSTD})$$

5. Calculate the Detection Limit:

Sodium Fluorescein: Using the known concentration value of SF and the calculated SNR: $1000/\text{SNR}$

- *Filter-based system, top optics:* The Detection Limit must be ≤ 10 pM (2 pg/mL) to pass.
- *Monochromator-based system, top/bottom optics:* The Detection Limit must be ≤ 20 pM (3.76 pg/mL) to pass.

Methylumbelliferone: Using the known concentration value of MUB and the calculated SNR: $17.6/\text{SNR}$

- *Filter-based system, top optics:* The Detection Limit must be ≤ 0.160 ng/mL to pass.
- *Monochromator-based system, top optics:* The Detection Limit must be ≤ 0.160 ng/mL to pass.

Linearity Test

1. Calculate the Mean of the four wells for each concentration in columns 1-5.
2. Perform linear regression using these values as inputs:

<i>Using Sodium Fluorescein</i>	
x	y
1000	Mean of the 1000 pM wells
500	Mean of the 500 pM wells
250	Mean of the 250 pM wells
125	Mean of the 125 pM wells
62.5	Mean of the 62.5 pM wells
<i>Using Methylumbelliferone</i>	
x	y
100	Mean of the 100 nM wells
50	Mean of the 50 nM wells
25	Mean of the 25 nM wells
12.5	Mean of the 12.5 nM wells
6.25	Mean of the 6.25 nM wells

3. Calculate the R^2 value; it must be ≥ 0.9500 to pass.

Fluorescence Polarization (FP) Test

1. Using the raw data from the Parallel read:
 - Calculate the Mean Blank (wells A6–H6).
 - Calculate the Signal for each HPR well: Subtract the Mean Blank from its measurement value.
 - Calculate the Signal for each LPR well: Subtract the Mean Blank from its measurement value.
2. Using the raw data from the Perpendicular read:
 - Calculate the Mean Blank (wells A6–H6).
 - Calculate the Signal for each HPR well: Subtract the Mean Blank from its measurement value.

- Calculate the Signal for each LPR well: Subtract the Mean Blank from its measurement value.
3. Calculate the G-Factor for each LPR well:

$$\frac{(\text{Parallel LPR Signal} \times (1 - 0.02))}{(\text{Perpendicular LPR Signal} \times (1 + 0.02))}$$
 4. Calculate the Mean G-Factor.
 5. Calculate the Polarization value in mP for each HPR well ("PHPR"):

$$\frac{(\text{Parallel HPR Signal} - \text{Mean G Factor} \times \text{Perpendicular HPR Signal})}{(\text{Parallel HPR Signal} + \text{Mean G Factor} \times \text{Perpendicular HPR Signal})} \times 1000$$
 6. Calculate the Mean PHPR, in mP.
 The Mean PHPR must be **>340 mP** to pass.
 7. Calculate the Polarization value in mP for each LPR well ("PLPR"):

$$\frac{(\text{Parallel LPR Signal} - \text{Mean G Factor} \times \text{Perpendicular LPR Signal})}{(\text{Parallel LPR Signal} + \text{Mean G Factor} \times \text{Perpendicular LPR Signal})} \times 1000$$
 8. Calculate the Standard Deviation of the "PLPR", in mP.
 The Standard Deviation of the PLPR must be **<5 mP** to pass.

Time-Resolved Fluorescence (TRF) Test

1. Calculate the Mean and Standard Deviation of the 16 reads for each of the buffer wells (A6, B6, C6).
2. Among the three buffer wells, find the Median Standard Deviation and corresponding Mean.
3. Calculate the Mean for the 16 reads of the Eu Concentration well (A8).
4. Calculate the Signal-to-Noise Ratio (SNR) using the Mean Eu Concentration and Buffer Median STD with its corresponding Buffer Mean:

$$\frac{(\text{Eu Mean} - \text{Buffer Mean})}{(3 \times \text{Buffer STD})}$$
5. Calculate the Detection Limit, in fM: $20000/\text{SNR}$
 The Detection Limit must be **<= 250 fM** to pass.

Troubleshooting

If a fluorescence liquid test fails, try the relevant suggestions below. If a test continues to fail, print the results and contact BioTek TAC.

- Are the solutions fresh? Discard open/unused buffer and stock solutions after seven days.
- Are the Excitation/Emission filters clean? Are they in the proper locations and in the proper orientation in the filter cube or wheel?
- Are you using new/clean plates? If the base of a clear-bottom plate is touched, clean the entire base with alcohol (95% ethanol) and then wipe with a lint-free cloth. Before placing the plate in the instrument, blow the bottom of the plate with an aerosol duster. If the test fails again, the optical probe(s) may need to be cleaned. Contact BioTek TAC for instructions.
- Review the pipetting instructions to verify the plate was correctly prepared.
- Does the Plate Type setting in the Gen5 protocol match the plate you used?
- For injector models, spilled fluid inside the reader may be fluorescing, which can corrupt your test results. If you suspect this is a problem, contact BioTek TAC for assistance.
- When testing Fluorescence Polarization capability using a solid black plastic microplate, if the standard deviation for the buffer wells is too high, try either moving the buffer wells to another column, or using the Greiner SensoPlate. With some black plastic plates, the wells in the center of the plate may be slightly distorted due to the plate molding process, and this can affect the standard deviation.
- If the Corners Test continues to fail, the hardware may be misaligned. Contact BioTek TAC.

Injection System Testing

For models equipped with injectors and an external dispense module, BioTek has developed a set of tests to ensure that the injection system performs to specification.

Test Method

The **Accuracy Test** is a measure of the mean volume per well for multiple dispenses. The actual weight of the dispensed fluid is compared to the expected weight and must be within a certain percentage to pass. Pass/Fail criteria depends on the per-well volume dispensed: 2.0% for 80 μL , 5.0% for 20 μL , and 20.0% for 5 μL .

The test uses a green dye test solution (available for purchase from BioTek, see page 5) and one 96-well microplate per injector to test the three different volumes. The balance is tared with the empty plate and the 80 μL dispense is performed for columns 1–4. The fluid is weighed and the balance is tared again with the plate. This process is repeated for the 20 μL and 5 μL dispenses.

It is assumed that one gram is equal to one milliliter and the solutions used are at room temperature. A three-place precision balance is used to weigh the plate.

The **Precision Test** is a measure of the variation among volumes dispensed to multiple wells, and uses the green test dye solution. For each volume dispensed (80 μL , 20 μL , and 5 μL) to four columns, the %CV of 32 absorbance readings is calculated. Pass/Fail criteria depends on the per-well volume dispensed: 2.0% for 80 μL , 7.0% for 20 μL , and 10.0% for 5 μL . Columns 1–4 are read at 405/750 nm and columns 5–12 at 630/750 nm.

The Accuracy and Precision tests are performed simultaneously and use the same plate.

Gen5 Parameters

The information in this section represents the recommended reading parameters for the referenced Gen5 protocol(s). It is possible that your tests will require modifications to some of these parameters, such as the Plate Type.

① The Plate Type setting in each Gen5 protocol should match the actual plate in use.

Synergy H1 Disp 1 Test.prt and **Synergy H1 Disp 2 Test.prt** (for use with models with Absorbance capability)

Parameter	Setting
Plate Type	96 WELL PLATE
Dispense Step	Dispenser <1 or 2> Wells A1–H4 Tip prime before this dispense step, 20 μL Dispense 80 μL at 275 $\mu\text{L}/\text{sec}$

Parameter	Setting
Plate Out,In	Comment: Weigh the plate (80 uL test). RECORD the weight, TARE the balance. Place the plate back on the carrier. Click OK to continue.
Dispense Step	Dispenser <1 or 2> Wells A5–H8 Tip prime before this dispense step, 20 µL Dispense 20 µL at 250 µL/sec
Plate Out,In	Comment: Weigh the plate (20 uL test). RECORD the weight, TARE the balance. Place the plate back on the carrier. Click OK to continue.
Dispense Step	Dispenser <1 or 2> Wells A9–H12 Tip prime before this dispense step, 5 µL Dispense 5 µL at 225 µL/sec
Plate Out,In	Comment: Weigh the plate (5 uL test). RECORD the weight, TARE the balance. PIPETTE 150 µL/well of DI water into all 12 columns. Place the plate back on the carrier. Click OK to perform the Read steps.
Shake Step	Linear, 15 seconds, default frequency
Read Step	Detection Method: Absorbance Read Type: Endpoint Optics Type: Monochromator Step label: 80 ul Read_Disp <1 or 2> Wells: A1–H4 Wavelengths, 2: 405 nm, 750 nm Speed: Normal
Read Step	Detection Method: Absorbance Read Type: Endpoint Optics Type: Monochromator Step label: 20 and 5 ul Read_Disp <1 or 2> Wells: A5–H12 Wavelengths, 2: 630 nm, 750 nm Speed: Normal
<i>Data Reduction</i>	Define two Delta OD transformations: 405–750 nm for the 80 uL Read step, columns 1–4 630–750 nm for the 20 and 5 uL Read step, columns 5-12

Synergy H1 Disp 1 Test No Read.prt and **Synergy H1 Disp 2 Test No Read.prt** (for use with models without Absorbance capability)

Parameter	Setting
Plate Type	96 WELL PLATE
Dispense Step	Dispenser <1 or 2> Wells A1..H4 Tip prime before this dispense step, 20 µL Dispense 80 µL at 275 µL/sec
Plate Out,In	Comment: Weigh the plate (80 uL test). RECORD the weight, TARE the balance. Place the plate back on the carrier. Click OK to continue.
Dispense Step	Dispenser <1 or 2> Wells A5..H8 Tip prime before this dispense step, 20 µL Dispense 20 µL at 250 µL/sec
Plate Out,In	Comment: Weigh the plate (20 uL test). RECORD the weight, TARE the balance. Place the plate back on the carrier. Click OK to continue.
Dispense Step	Dispenser <1 or 2> Wells A9..H12 Tip prime before this dispense step, 5 µL Dispense 5 µL at 225 µL/sec
Plate Out,In	Comment: Weigh the plate (5 uL test). RECORD the weight, TARE the balance. PIPETTE 150 µL/well of DI water into all 12 columns. Set the plate aside and click OK.
Read Step	<i>Define a brief Read step for a single well. The measurement value will not be used. The step is only necessary because Gen5 requires a Read step with dispense protocols.</i>

Synergy H1 Disp Test Other Reader.prt (for use with a BioTek absorbance-capable reader other than Synergy H1)

Parameter	Setting
Shake Step	<medium intensity> for 15 seconds
Read Step	Detection Method: Absorbance Read Type: Endpoint Optics Type: <as appropriate for the reader type> Step label: 80 ul Read Wells: A1..H4 Wavelengths, 2: 405 nm, 750 nm Speed: Normal

Parameter	Setting
Read Step	Detection Method: Absorbance Read Type: Endpoint Optics Type: <as appropriate for the reader type> Step label: 20 and 5 ul Read Wells: A5..H12 Wavelengths, 2: 630 nm, 750 nm Speed: Normal
Data Reduction	Define two Delta OD transformations: 405-750 nm for the 80 ul Read step, columns 1-4 630-750 nm for the 20 and 5 ul Read step, columns 5-12

Results Analysis

The Injection System Test procedures begin on page [134](#).

When the experiment for one injector is complete, 32 delta OD values are reported for each of the three dispense volumes. The pass/fail criteria for each set of 32 wells with the same dispense volume is based on the calculated coefficient of variation (% CV) and Accuracy % Error.

For each volume dispensed (80 µL, 20 µL, 5 µL), for each injector (1, 2):

1. Calculate the Standard Deviation of the 32 wells
2. Calculate the Mean of the 32 wells
3. Calculate the %CV: (Standard Deviation / Mean) x 100
4. Calculate the Accuracy % Error:

$$((\text{ActualWeight} - \text{ExpectedWeight}) / \text{ExpectedWeight}) * 100$$

Expected Weights for 32 wells: 80 µL (2.560 g), 20 µL (0.640 g), 5 µL (0.160 g).
It is assumed that one gram is equal to one milliliter.

Dispense Volume	To pass, %CV must be:	To pass, Accuracy % Error must be:
80 µL	≤ 2.0%	≤ 2.0%
20 µL	≤ 7.0%	≤ 5.0%
5 µL	≤ 10.0%	≤ 20.0%

If any tests fail, prime the fluid lines and rerun the tests. If the tests fail again, the injectors may require cleaning; see [Clean the Dispense Tubes and Injectors](#) on page [63](#). If tests continue to fail, contact BioTek TAC.

Instrument Qualification Procedures

This chapter contains the step-by-step procedures for verifying that the Synergy H1 and its various sub-systems are performing to specification.

Instrument Qualification Process starting on page 73 introduces the various test methods, describes the materials and relevant Gen5 protocols used to execute the tests, explains how to analyze test results, and provides troubleshooting tips in the event of a failure.

Overview	108
IQ/OQ/PQ Description	109
Recommended Qualification Schedule	110
System Test	111
Absorbance Plate Tests	112
Absorbance Liquid Tests	114
Luminescence Test	119
Fluorescence Plate Tests	120
Fluorescence Liquid Tests	121
Injection System Tests	134

Overview

This chapter contains BioTek Instrument's recommended qualification procedures for all Synergy H1 models.

Every Synergy H1 is fully tested at BioTek prior to shipment and should operate properly upon initial setup. If you suspect that a problem occurred during shipment, if you have received the equipment after returning it to the factory for service, and/or if regulatory requirements dictate that you qualify the equipment on a routine basis, perform the procedures outlined in this chapter.

See the [Recommended Qualification Schedule](#) on page 110 to determine which qualification tests shall be conducted for your Synergy H1 model and to meet your site's regulatory requirements.

A Product Qualification Package (BTI #8040528) for the Synergy H1 is available for purchase. The package contains test procedures, Gen5 protocols, checklists, and logbooks for performing Installation Qualification, Operational Qualification, Performance Qualification, and Preventive Maintenance. Contact your BioTek dealer for more information.

If the gas controller module is used with the Synergy H1, refer to the *Gas Controller User Guide* (BTI #1211000) or *Gas Controller Product Qualification Package* (BTI #1210512) for qualification procedures.

IQ/OQ/PQ Description

Installation Qualification confirms that the reader and its components have been supplied as ordered and ensures that they are assembled and configured properly for your lab environment.

- The recommended IQ procedure consists of setting up the instrument and its components as described in the Installation chapter, and performing the System Test. For models with injectors, a quick test with fluid is also performed, to ensure that the dispense module is properly installed and there are no leaks.
- The IQ procedure should be performed before the reader is used for the first time. The successful completion of the IQ procedure verifies that the instrument is installed correctly.

Operational Qualification confirms that the equipment operates according to specification initially and over time.

- The recommended OQ procedure consists of performing the System Test, Absorbance Plate Test, a series of Fluorescence Tests, and, if the external dispense module is used, Dispense Accuracy and Precision Tests.
- The OQ procedure should be performed initially (before first use) and then routinely; the recommended interval is annually. It should also be performed after any major repair or upgrade to the hardware or software.
- Although out-of-tolerance failures will be detected by the OQ tests, results should be compared with those from the routine Performance Qualification tests and previous OQ tests to monitor for trends.
- The successful completion of the OQ procedure, in combination with results that are comparable to previous PQ and OQ tests, confirms that the equipment is operating according to specification initially and over time.

Performance Qualification confirms that the reader consistently meets the requirements of the tests performed at your laboratory.

- The recommended PQ procedure consists of performing the System Test, Absorbance Plate Test, a series of Fluorescence Tests, and, if the external dispense module is used, Dispense Accuracy and Precision Tests. Your facility's operating policies may also require that you routinely perform an actual assay, to confirm that the reader will consistently give adequate results for the assays to be run on it.
- These tests should be performed routinely; the recommended interval is monthly or quarterly, depending on the test. This frequency may be adjusted depending on the trends observed over time.
- The successful completion of the PQ procedure confirms that the equipment is performing consistently under normal operating conditions.

Recommended Qualification Schedule

The schedule below defines BioTek-recommended intervals for qualifying a Synergy H1 used two to five days a week. The actual frequency, however, may be adjusted depending on your usage of the instrument and its various modules. This schedule assumes the reader is properly maintained as outlined in the **Preventive Maintenance** chapter.

Tasks/Tests	IQ	OQ	PQ	
	Initially	Initially/ Annually	Monthly	Quarterly
All models:				
Installation, setup, and configuration of the reader, host computer, and Gen5 software	✓			
System Test	✓	✓	✓	
Models with absorbance capability:				
Absorbance Plate Test		✓	✓	
Absorbance Liquid Test 1 <u>or</u> Liquid Test 2*		✓		✓
(Optional) Absorbance Liquid Test 3 <i>or</i> 340 nm Absorbance Plate Test (using BTI #7260551)		✓		✓
Models with fluorescence capability:				
Corners, Sensitivity, Linearity (FI) Tests		✓	✓	
Fluorescence Polarization (FP) Test		✓		✓
Time-Resolved Fluorescence (TRF) Test		✓		✓
Models with luminescence capability:				
Luminescence Test		✓	✓	
Models with injectors and an external dispense module:				
Installation and setup of external dispense module	✓			
Injection System Test	✓			
Dispense Accuracy and Precision Test		✓		✓

* If you have Absorbance Test Plate BTI #7260522, perform Liquid Test 1. Otherwise, perform Liquid Test 2.

System Test

Instrument System Test starting on page 74 describes this test and explains where to find information on error codes and troubleshooting tips, as well as sample test reports for Synergy H1.

Setup

- If your assays use incubation, we recommend enabling temperature control for at least 37°C and allowing the incubator to reach its set point before running the System Test. To access this feature, select **System > Instrument Control** and click the **Pre-Heating** tab.

Test Procedure

1. From the Gen5 main screen, select **System > Diagnostics > Run System Test**.

The duration of the test depends on the reader model; it can take a few minutes to complete.

If the test fails during execution, a message box will appear in Gen5. Close the box; the System Test Report will contain the error code that was generated by the failure.

2. When the test is complete, a dialog will appear, requesting additional information. Enter any required information and then click **OK**.
3. The test report will appear; it will show either "SYSTEM TEST PASS" or "SYSTEM TEST FAIL *** ERROR (error code) DETECTED."
If the test failed, go to page 145 to look up the error code and determine its cause. If the cause is something you can fix, turn off the reader, fix the problem, and then turn the reader back on and retry the test. If the test continues to fail, or if the cause is not something you can fix, contact BioTek TAC.
4. If required, print, sign, and date the report, and store it with your test documentation.
5. If applicable, turn off the incubator.

Absorbance Plate Tests

BioTek Absorbance Test Plates starting on page 75 describes the test methods and provides troubleshooting tips in the event of test failure.

① The diagnostics feature in Gen5 versions **2.08** and higher is compatible with the 340 nm Absorbance Test Plate BTI #7260551. If you are using an earlier Gen5 version, refer to the test plate's instruction sheet to manually conduct the tests and analyze results.

Requirements

To perform this test, you will need:

- Absorbance Test Plate, BTI #7260522
- (Optional) 340 nm Absorbance Test Plate, BTI #7260551
- Current Absorbance Test Plate Calibration Certificate(s)

Setup

Before an Absorbance Test Plate can be used for qualification, you must enter information from its Calibration Certificate into Gen5. Perform these steps initially, and then repeat them annually after the test plate is recertified by BioTek:

1. Obtain the current Test Plate Calibration Certificate.
2. Start Gen5 and select **System > Diagnostics > Test Plates > Add/Modify Plates**.
3. Click **Add**. The Absorbance Test Plate dialog appears.
4. Select the appropriate Plate Type and then enter the plate's serial number.
5. Enter the Last Certification and Next Certification dates from the calibration label on the Test Plate.
6. If the wavelength values in the top row of the grid in Gen5 are appropriate for your tests, enter the OD Standard values from the Calibration Certificate into the grid. Make sure you enter the correct value for each well/wavelength combination.

If you need to change the wavelength values, click **Wavelength List**. Add, change, or delete the values as needed and click **OK**.

7. If applicable: Select the number of Peak Wavelength tests to run (up to 4), based on the desired Expected Peak wavelengths provided on the Calibration Certificate. Enter the Expected Peak value(s) from the Certificate and set the Test Range – and + values.

Depending on the manufacture date of the test plate, the glass type may be Erbium, Holmium, or Didymium. Contact BioTek TAC if you are not sure which glass type is used in your plate.

- If the C6 filter is Erbium or Holmium glass, the certificate contains two Spectral Bandpass tables.

Synergy H1 has a bandpass wider than 5 nm for wavelengths above 285 nm and smaller than 4 nm for 230–285 nm; we recommend you use the expected peak values in the **5.0 nm** table.

Erbium: Any peak value in the table can be used.

Holmium: For best results use the expected peak values *closest to* 242, 279, 362, 417, and 538 nm.

- If the C6 filter is Didymium glass, the certificate provides a single peak wavelength value. Enter this value into Gen5 and set the Test Range – and + values so the range displayed in parenthesis is "(580 to 590)".
8. Review all of the values that you entered. When finished, click **OK** to save the information.

Test Procedure

1. In Gen5, select **System > Diagnostics > Test Plates > Run**. If prompted, select the desired Test Plate and click **OK**.
2. When the Absorbance Test Plate Options dialog appears, enter any required information.
3. If applicable, check the **Perform Peak Wavelength Test box**.
4. Highlight the wavelength(s) to be included in this test. Select only those wavelengths most appropriate for your use of the reader.
5. (Optional) Enter a comment.
6. Click **Start Test**.
7. Place the Absorbance Test Plate on the microplate carrier, with A1 in the proper location.
8. Click **OK** to run the test.
9. When the test completes, the results report will appear. Scroll down through the report; every result should show "PASS".
 - Troubleshooting tips are provided on page [76](#).
 - Test descriptions are provided on page [75](#).

Absorbance Liquid Tests

Absorbance Liquid Tests starting on page 77 describes the test methods, lists the Gen5 protocol parameters, explains how to analyze the test results, and provides troubleshooting tips in the event of test failure.

Absorbance Liquid Test 1



The tests in this section require specific microplates, solutions, and filters or wavelengths. Your laboratory may require a deviation from some of these tests. For example, you may wish to use a different plate or test solution. If deviation from the tests as presented in this section is required, perform the following steps the first time each test is run:

- Perform the tests exactly as described here.
- Rerun the tests using your particular plates, solutions, and so on.
- If results are comparable, then the results from these tests will be your baseline for future tests. Document your new test procedure and save all test results.

Materials

Manufacturer part numbers are subject to change.

- New 96-well clear flat-bottom microplate (Corning Costar #3590 recommended)
- Stock Solution A or B, which may be formulated by diluting a dye solution available from BioTek (A) or from the materials listed below (B)
- Gen5 protocol **Synergy H1 Abs Test 1.prt** described on page 78

Solution A

- BioTek QC Check Solution No. 1 (PN 7120779, 25 mL; PN 7120782, 125 mL)
 - Deionized water
 - 5-mL Class A volumetric pipette
 - 100-mL volumetric flask
1. Pipette a 5-mL aliquot of BioTek QC Check Solution No. 1 into a 100-mL volumetric flask.
 2. Add 95 mL of DI water; cap and shake well. The solution should measure approximately 2.000 OD when using 200 μ L in a flat-bottom microwell.

Solution B

- Deionized water
 - FD&C Yellow No. 5 dye powder (typically 90% pure)
 - Tween 20 (polyoxyethylene (20) sorbitan monolaurate) or BioTek wetting agent (PN 7773002) (a 10% Tween solution)
 - Precision balance with capacity of 100 g minimum and readability of 0.001 g
 - Weigh boat
 - 1-liter volumetric flask
1. Weigh out 0.092 g of FD&C Yellow No. 5 dye powder into a weigh boat.
 2. Rinse the contents into a 1-liter volumetric flask.
 3. Add 0.5 mL of Tween 20, or 5 mL of BioTek's wetting agent.
 4. Fill to 1 liter with DI water; cap and shake well. The solution should measure approximately 2.000 OD when using 200 μ L in a flat-bottom microwell.

Test Procedure

① Be sure to use a new microplate. Debris, fingerprints, or scratches may cause variations in readings.

1. Using freshly prepared stock solution (Solution A or B), prepare a 1:2 dilution using deionized water (one part stock, one part deionized water; the resulting solution is a 1:2 dilution).
2. Pipette 200 μ L/well of the stock solution into column 1.
3. Pipette 200 μ L/well of the diluted solution into column 2.
4. Create a Gen5 experiment based on the **Synergy H1 Abs Test 1** protocol and read the plate. When prompted, rotate the plate 180 degrees and continue.
5. When the experiment is finished:
 - Save the experiment. Refer to the instructions on page 80 to perform calculations and determine pass/fail.
 - Troubleshooting tips are provided on page 82.
 - Test descriptions are provided on page 77.

Absorbance Liquid Test 2

The recommended method for testing the instrument's alignment, repeatability, and accuracy is to use Absorbance Test Plate BTI #7260522 (see page 112). If the test plate is not available, however, Liquid Test 2 can be used for these tests.

Materials

Manufacturer part numbers are subject to change.

- New 96-well clear flat-bottom microplate (Corning Costar #3590 recommended)
- Ten test tubes, numbered consecutively, set in a rack
- Calibrated hand pipette (Class A volumetric pipette recommended)
- Stock Solution A or B (see instructions for Liquid Test 1)
- 0.05% solution of deionized water and Tween 20
- Gen5 protocol **Synergy H1 Abs Test 2.prt** described on page 79

Test Procedure

1. Create a percentage dilution series, beginning with 100% of the original concentrated stock solution (A or B) in the first tube, 90% of the original solution in the second tube, 80% in the third tube, all the way to 10% in the tenth tube. Dilute using the 0.05% solution of deionized water and Tween 20. This solution can also be made by diluting the BioTek wetting agent 200:1.

Tube Number	1	2	3	4	5	6	7	8	9	10
Volume of original concentrated solution (mL)	20	18	16	14	12	10	8	6	4	2
Volume of 0.05% Tween solution (mL)	0	2	4	6	8	10	12	14	16	18
Absorbance expected if original solution is 2.000 OD at 200 μ L	2.0	1.8	1.6	1.4	1.2	1.0	0.8	0.6	0.4	0.2

The choice of dilutions and the absorbance of the original solution can be varied. Use this table as a model for calculating the expected absorbances of a series of dilutions, given a different absorbance of the original solution.

2. Pipette 200 μ L of the concentrated solution from Tube 1 into each well of the first column, A1 to H1, of a new flat-bottom microplate.
3. Pipette 200 μ L from each of the remaining tubes into the wells of the corresponding column of the microplate (Tube 2 into wells A2 to H2, Tube 3 into wells A3 to H3, and so on).
4. Create a Gen5 experiment based on the **Synergy H1 Abs Test 2** protocol and read

the plate. When prompted, rotate the plate 180 degrees.

5. When finished:

- Save the experiment. Refer to the instructions on page 80 to perform calculations and determine pass/fail.
- Troubleshooting tips are provided on page 82.
- Test descriptions are provided on page 75.

Absorbance Liquid Test 3

Absorbance Liquid Test 3 is provided for sites requiring proof of linearity at 340 nm. This test is optional because the Synergy H1 has good "front end" linearity throughout its wavelength range. As an alternative, the 340 nm Absorbance Test Plate (BTI #7260551) may be used for this test.

Materials

Manufacturer part numbers are subject to change.

- New 96-well clear flat-bottom microplate (Corning Costar #3590 recommended)
- Calibrated hand pipette(s)
- Beakers and graduated cylinder
- Precision balance with readability to 0.010 g
- Buffer solution described below
- Gen5 protocol **Synergy H1 Abs Test 3.prt** described on page 79

Buffer Solution

- Deionized water
 - Phosphate-Buffered Saline (PBS), pH 7.2–7.6, Sigma tablets, #P4417 (or equivalent)
 - β -NADH Powder (β -Nicotinamide Adenine Dinucleotide, Reduced Form) Sigma bulk catalog number N 8129, or preweighed 10-mg vials, Sigma number N6785-10VL (or BioTek PN 98233). Store the powder according to the guidelines on its packaging.
1. Prepare a PBS solution from the Sigma tablets.
 2. In a beaker, mix 50 mL of the PBS solution with 10 mg of the β -NADH powder and mix thoroughly. This is the **100% Test Solution**.
 3. (Optional) Read a 150- μ L sample of the solution at 340 nm; it should be within 0.700 to 1.000 OD. If low, adjust up by adding more powder. Do not adjust if slightly high.

Test Procedure

1. Prepare the **75% Test Solution** by mixing 15 mL of the 100% Test Solution with 5 mL of the PBS Solution.
2. Prepare the **50% Test Solution** by mixing 10 mL of the 100% Test Solution with 10 mL of the PBS Solution.
3. Carefully pipette the three solutions into a new 96-well microplate:
 - 150 μ L of the 100% Test Solution into all wells of columns 1 and 2
 - 150 μ L of the 75% Test Solution into all wells of columns 3 and 4
 - 150 μ L of the 50% Test Solution into all wells of column 5 and 6
4. Create a Gen5 experiment based on the **Synergy H1 Abs Test 3** protocol and read the plate.
 - Save the experiment. Refer to the instructions on page [81](#) to perform calculations and determine pass/fail.
 - Troubleshooting tips are provided on page [82](#).
 - Test descriptions are provided on page [77](#).

Luminescence Test

Luminescence Testing starting on page 83 describes the test method, lists the Gen5 protocol parameters, explains how to analyze the test results, and provides troubleshooting tips in the event of test failure.

Requirements

To perform this test, you will need:

- Harta Luminometer Reference Microplate, BioTek #8030015 (which includes microplate carrier adapter BTI #8042263)
- Gen5 protocols, described on page 83:
 - **Synergy H1 F-LumTest_Harta** (filter-based system)
 - **Synergy H1 M-LumTest_Harta** (monochromator-based system)
- For use only with the filter-based test, the following filter set defined in Gen5:
 - Filter Set Name: **Open**
 - Excitation: **Plug**
 - Mirror: **<none>**
 - Emission: **Hole**

Test Procedure

1. Turn on the Harta reference plate using the I/O switch on the back of the plate.
2. Check the battery by pressing the test button on the back of the plate and ensuring that the test light turns on. The test light may be difficult to see in bright light; change your angle of view or move to a darker environment if necessary. If the light does not turn on, replace the battery.
3. Place the adapter on the reader's microplate carrier and then place the Harta reference plate on top of the adapter.
4. In Gen5, create an experiment based on the **Synergy H1 F-Lum-Test** (filter-based) protocol and initiate a plate read.

The experiment begins with a three-minute Delay step.

5. When the experiment is complete, calculate and evaluate results as described under *Results Analysis* on page 85.
6. Repeat steps 4 and 5 using the **Synergy H1 M-LumTest_Harta** (monochromator-based) protocol.
7. When finished, turn off the Harta reference plate to preserve battery life.

Fluorescence Plate Tests

BioTek Fluorescence Test Plate on page 87 introduces the test plate and references the User Guide for the test methods. Use of the test plate is offered as an alternative to conducting the fluorescence liquid tests described in the next section.

Requirements

Refer to the **Getting Started** section of the *Fluorescence Test Plate User Guide* for information on the required materials and prerequisite tasks.

Test Procedure

The **Qualification Tests** section of the *Fluorescence Test Plate User Guide* contains a procedure for cleaning the plate and then creating and running experiments based on supplied Gen5 protocols.

As described in the User Guide, when each experiment is finished, Gen5 exports the measurement data to a prepared Microsoft Excel .xls file. The worksheet(s) within that file calculate results and determine pass or fail.

① For use with the Synergy H1, identify the reader-specific Gen5 protocols on the USB flash drive that came with the test plate. Use only those protocols that apply to your reader model and your organization's qualification requirements.

Fluorescence Liquid Tests

Fluorescence Liquid Tests starting on page 88 describes the test methods, lists the Gen5 protocol parameters, explains how to analyze the test results, and provides troubleshooting tips in the event of test failure.



The tests in this section require specific microplates, solutions, and filters or wavelengths. Your laboratory may require a deviation from some of these tests. For example, you may wish to use a different plate or test solution. If deviation from the tests as presented in this section is required, perform the following steps the first time each test is run:

- Perform the tests exactly as described here.
- Rerun the tests using your particular plates, solutions, and so on.
- If results are comparable, then the results from these tests will be your baseline for future tests. Document your new test procedure and save all test results.

Materials



Kits containing the microplates and solutions required by the Liquid Tests are available for purchase; see *Materials for Conducting Liquid Tests* on page 5.

① Microplates should be clean and free from dust and bottom scratches. Use new microplates from sealed packages.

Manufacturer part numbers are subject to change.

All tests:

- Deionized or distilled water
- Various beakers, graduated cylinders, and pipettes
- 95% ethanol (for cleaning clear-bottom plates)
- Aluminum foil
- (Optional, but recommended) 0.45-micron filter
- (Optional) Black polyethylene bag(s) to temporarily store plate(s)

- Gen5 protocols listed below (as applicable for your reader model) and described in detail under [Gen5 Protocol Parameters](#) starting on page 88

For the **filter-based** fluorescence system:

Synergy H1_FI_T_SF.prt	Corners, Sensitivity, Linearity tests, Top optics, Sodium Fluorescein (SF)
Synergy H1_FI_T_MUB.prt	Sensitivity and Linearity tests, Top optics, Methylumbelliferone (alternate/ supplemental test for Top optics)
Synergy H1_FP.prt	Fluorescence Polarization (FP) test
Synergy H1_TRF.prt	Time-Resolved Fluorescence (TRF) test

For the **monochromator-based** fluorescence system:

Synergy H1_M_FI_B_SF.prt	Corners, Sensitivity, Linearity tests, Bottom optics, Sodium Fluorescein (SF)
Synergy H1_M_FI_T_SF.prt	Corners, Sensitivity, Linearity tests, Top optics, Sodium Fluorescein (SF)
Synergy H1_M_FI_T_MUB.prt	Sensitivity and Linearity tests, Top optics, Methylumbelliferone (alternate/ supplemental test for Top optics)

- Filter set definitions, as applicable ("Green"=SF, "Blue"=MUB):

Filter Set Name	Green
Excitation:	Band Pass, 485/20
Mirror:	Dichroic, Top 510 nm (440/505, 515/640)
Emission:	Band Pass, 528/20
Filter Set Name	Blue
Excitation:	Band Pass, 360/40
Mirror:	Dichroic, Top 400 nm (320/390, 410/800)
Emission:	Band Pass, 460/40
Filter Set Name	TRF
Excitation:	Band Pass, 360/40
Mirror:	Dichroic, Top 400 nm (320/390, 410/800)
Emission:	Band Pass, 620/40
Filter Set Name	FP (enable 'Fluorescence Polarization Cube')
Excitation:	Band Pass, 485/20
Mirror:	Dichroic, Top 510 nm (440/505, 515/640)
Emission:	Band Pass, 528/20

Corners/Sensitivity/Linearity (FI) Tests:

The materials listed here are for use with Sodium Fluorescein. Methylumbelliferone (MUB) may be used as an alternate or supplemental method for conducting the FI tests for the Top optics; see page 130.

If using test kit BTI #7160010 or #7160013 (see page 5) the buffer and SF are pre-diluted.

- Buffer:
 - NIST-traceable Sodium Borate Reference Standard (pH 9.18) (e.g., Fisher-Scientific 1 L Sodium Borate Mfr. #159532, or equivalent), **or**
 - Phosphate-Buffered Saline (PBS), pH 7.2–7.6 (e.g., Sigma tablets, Mfr. #P4417, or equivalent) and pH meter or pH indicator strips with range 4–10
- Sodium Fluorescein Powder (1-mg vial, BioTek PN 98155)
- If testing both Top and Bottom optics (monochromator-based fluorescence only):
 - A new, clean 96-well glass-bottom Greiner SensoPlate (Mfr. #655892); or a clean Hellma Quartz 96-well titration plate (Mfr. #730.009.QG); or equivalent
- If testing only the Top optics:
 - A new, clean 96-well solid black microplate, such as Corning Costar #3915, or equivalent
- Excitation filter 485/20 nm installed
- Emission filter 528/20 nm installed
- 510 nm dichroic mirror installed

Fluorescence Polarization (FP) Test:

The FP Test may be conducted using the same plate as for the **Top Corners/Sensitivity/Linearity (FI) Tests**.

- The recommended test solutions are available from Invitrogen Corporation in their "FP One-Step Reference Kit" (#P3088) or BioTek (#7160014; see page 5). This kit includes:
 - (Green) Polarization Reference Buffer, 15 mL
 - Green Low Polarization Reference, 4 mL
 - Green High Polarization Reference, 4 mL
 - The Invitrogen kit also includes two red polarization solutions, not used
- A new, clean, 96-well solid black microplate, such as Corning Costar #3915. A Greiner SensoPlate can also be used.
- Excitation filter 485/20 nm installed

- Emission filter 528/20 nm installed
- 510 nm dichroic mirror and polarizers installed

Time-Resolved Fluorescence (TRF) Test:

BioTek offers a pre-configured qualification TRF filter cube for purchase; contact BioTek Customer Care and ask about part number 8040555.

- The recommended test solution (FluoSpheres carboxylate-modified microspheres, 0.2 μm europium luminescent, 2 μL) is available from Invitrogen Corporation (#F20881) or BioTek (#7160011; see page 5)
- A new, clean 96-well solid white microplate, such as Corning Costar #3912
- 15-mL conical-bottom, polypropylene sample tube
- Excitation filter 360/40 nm installed
- Emission filter 620/40 nm installed
- 400 nm dichroic mirror installed

Test Solutions

Determine which tests to run for your reader model. Prepare the necessary test solutions using the materials described on the previous pages.

Corners/Sensitivity/Linearity (FI) Tests:



If using BioTek's sodium fluorescein powder (BTI #98155), be sure to hold the vial upright and open it carefully; the material may be concentrated at the top. If a centrifuge is available, spin down the tube before opening.

When diluting the sodium fluorescein powder in buffer, it takes time for the powder to completely dissolve. Allow the solution to dissolve for five minutes, with intermittent vortexing, before preparing the titration dyes.

Wrap the vial containing the stock solution in foil to prevent exposure to light. Discard unused solution after seven days. Discard any open, unused buffer solution after seven days.

1. The Sodium Borate solution does not require further preparation; proceed to step 2. If you are using PBS, prepare the solution:
 - (Optional, but recommended) Using a 0.45-micron filter, filter 200 mL of deionized or distilled water.
 - Follow the manufacturer's instructions on the PBS packaging to create 200 mL, dissolving the necessary amount of PBS into the filtered water.

- Stir the solution (preferably using a stir table) until the PBS is completely dissolved.
 - Check the pH; it should be between 7.2 and 7.6 at 25°C.
2. Prepare the sodium fluorescein stock solution:
 - Add 2.0 mL of the buffer solution to the 1 mg Sodium Fluorescein (SF) vial. This yields a 1.3288 mM stock solution.
 - Ensure that the dye has completely dissolved and is well mixed.
 3. Carefully prepare the dilutions. Label each with "SF" and the concentration:

Mix this SF solution:	with buffer:	to make:	
0.53 mL of 1.3288 mM stock solution	13.47 mL	50.2 μ M	
110 μ L of 50.2 μ M SF	13.89 mL	400 nM	
3.5 mL of 400 nM SF	10.50 mL	100 nM	
0.46 mL of 100 nM SF	13.54 mL	3.3 nM	<i>Corners Test</i>
4.24 mL of 3.3 nM SF	9.76 mL	1 nM	<i>Sensitivity/Linearity Tests</i>

Fluorescence Polarization (FP) Test:

As described in the [Materials](#) section, the recommended test solutions are available from Invitrogen Corporation (or BioTek). They do not require additional preparation.

Time-Resolved Fluorescence (TRF) Test:

As described in the [Materials](#) section, the recommended test solutions are available from Invitrogen Corporation (or BioTek).

- Shake the FluoSpheres container vigorously for 30 seconds prior to pipetting. Alternatively, sonicate or vortex the container.
- Mix 10 μ L of FluoSpheres with 10 mL of deionized water, in a 15-mL conical-bottom, polypropylene sample tube. This yields a 20-nM equivalent suspension.
- Shake the vial vigorously for 30 seconds prior to pipetting. Alternatively, sonicate or vortex the container.
- Mix 10 μ L of 20-nM suspension with 10 mL of deionized water, in a 15-mL conical-bottom, polypropylene sample tube. This yields a 20-pM equivalent suspension.
- Refrigerate any unused portions of the FluoSpheres. The temperature must be between +2°C to +6°C.

The prepared TRF plate can be kept for a maximum of seven days, if covered and stored in the dark between +2°C to +6°C. Allow the plate to sit at room temperature for approximately 15 minutes prior to use. Shake the plate gently prior to the read.

Test Procedure

1. If you have not already done so, prepare the solutions for the tests you plan to perform. See instructions starting on page [124](#).

Refer to the pipette maps on the next few pages for the remaining steps.

2. Perform the Corners/Sensitivity/Linearity tests using the Top optics of the filter-based fluorescence system:
 - Pipette the solutions into a new 96-well solid black or glass-bottom plate.
 - Create an experiment based on **Synergy H1_FI_T_SF.prt** and read the plate.
3. If your reader is equipped with Fluorescence Polarization capability:
 - Pipette the solutions for the "FP" test into the same plate as used in step 2.
 - Create an experiment based on **Synergy H1_FP.prt** and read the plate.
4. If your reader is equipped with the monochromator-based fluorescence system, perform the Sensitivity/Linearity tests for that system:
 - Create an experiment based on **Synergy H1_M_FI_B_SF.prt** (bottom optics) and read the plate.
 - Create an experiment based on **Synergy H1_M_FI_T_SF.prt** (top optics) and read the plate.
5. If your reader is equipped with Time-Resolved Fluorescence capability:
 - Pipette the solutions for the "TRF" test into a new 96-well solid white plate.
 - Create an experiment based on **Synergy H1_TRF.prt** and read the plate.
6. Save the experiments. Refer to the instructions starting on page [98](#) to perform calculations and determine pass/fail.
 - Troubleshooting tips are provided on page [101](#).
 - Test descriptions are provided on page [88](#).

Pipette Maps

Seal the plates with foil or store them in black polyethylene bags until use. When using a clear-bottom plate, if the base of the plate is touched, clean the entire base with alcohol (95% ethanol) and then wipe with a lint-free cloth. Before placing the plate in the instrument, blow the bottom of the plate with an aerosol duster.

Corners, Sensitivity, and Linearity (FI) Tests:

Refer to the illustration on the next page.

Using a single-channel pipette:

- Pipette **200 μ L** of the **3.3 nM SF** solution into the "corner" wells.
- Pipette 200 μ L of the buffer in the wells surrounding the SF. (Omit if using a solid black plate or Greiner SensoPlate.)
- Pipette 200 μ L of the **1 nM SF** solution into well D7.
- Pipette 200 μ L of the buffer solution into wells C9, D9, and E9.

Using a multi-channel pipette with just four tips installed:

- Pipette **150 μ L** of the buffer into wells C2-F5. Discard the tips.
- Pipette 150 μ L of the **1 nM SF** solution into column 1.
- Pipette 150 μ L of the 1 nM SF solution into column 2. Mix the wells using the pipette. Do not discard the tips.
- Aspirate 150 μ L from column 2 and dispense into column 3. Mix the wells using the pipette. Do not discard the tips.
- Aspirate 150 μ L from column 3 and dispense into column 4. Mix the wells using the pipette. Do not discard the tips.
- Aspirate 150 μ L from column 4 and dispense into column 5. Mix the wells using the pipette. Do not discard the tips.
- Aspirate 150 μ L from column 5. Discard the solution and the tips.

		1	2	3	4	5	6	7	8	9	10	11	12
<i>Corners</i>	A	3.3 nM	3.3 nM	3.3 nM	BUF					BUF	3.3 nM	3.3 nM	3.3 nM
	B	BUF	BUF	BUF	BUF					BUF	BUF	BUF	BUF
	C	150 μL: 1 nM	0.5 nM	0.25 nM	0.125 nM	0.0625 nM				BUF			
<i>Sensitivity /Linearity</i>	D	1 nM	0.5 nM	0.25 nM	0.125 nM	0.0625 nM		200 μL: 1 nM		BUF			
	E	1 nM	0.5 nM	0.25 nM	0.125 nM	0.0625 nM				BUF			
	F	1 nM	0.5 nM	0.25 nM	0.125 nM	0.0625 nM							
	G	BUF	BUF	BUF	BUF					BUF	BUF	BUF	BUF
<i>Corners</i>	H	3.3 nM	3.3 nM	3.3 nM	BUF					BUF	3.3 nM	3.3 nM	3.3 nM

Fluorescence Polarization (FP) Test:

The plate used for testing Corners/Sensitivity/Linearity of the Top optics can also be used for this test.

- Pipette 200 μL of the (green) polarization buffer (BUF) into wells A6–H6.
- Pipette 200 μL of the green high polarization reference (HPR) into wells A7–B7.
- Pipette 200 μL of the green low polarization reference (LPR) into wells A8–H8.

	1	2	3	4	5	6	7	8	9	10	11	12
A						BUF	HPR	LPR				
B						BUF	HPR	LPR				
C						BUF		LPR				
D						BUF		LPR				
E						BUF		LPR				
F						BUF		LPR				
G						BUF		LPR				
H						BUF		LPR				

Time-Resolved Fluorescence (TRF) Test:

- Pipette 200 μ L of deionized water (DI) into wells A6, B6, C6.
- If you have not already done so, shake the vial of 20 pM europium suspension vigorously for 30 seconds prior to pipetting. Alternatively, sonicate or vortex the vial.
- Pipette 200 μ L of the 20 pM europium suspension (Eu) into well A8.

	1	2	3	4	5	6	7	8	9	10	11	12
A						DI		Eu				
B						DI						
C						DI						
D												
E												
F												
G												
H												

Alternate/Supplemental Tests Using Methylumbelliferone (MUB)

(Optional) As an alternative to using Sodium Fluorescein, Methylumbelliferone (MUB) can be used to perform the Sensitivity/Linearity tests for the top optics.

Materials



Kits containing the microplates and solutions required by the Liquid Tests are available for purchase; see [Materials for Conducting Liquid Tests](#) on page 5.

Manufacturer part numbers are subject to change.

If your reader is equipped with the filter- and monochromator-based fluorescence systems, the same microplate is used to test both systems.

- Methylumbelliferone (MUB) (10-mg vial, BTI #98156)
- Carbonate-Bicarbonate buffer (CBB) capsules (Sigma #3041)
- 100% methanol (BTI #98161)
- A new, clean 96-well solid black plate, such as Corning Costar #3915 or equivalent. A Greiner SensoPlate (Mfr. #655892) may also be used.
- Excitation filter 360/40 installed
- Emission filter 460/40 nm installed
- 400 nm dichroic mirror installed
- Deionized or distilled water
- Various beakers, graduated cylinders, and pipettes
- 95% ethanol (for cleaning clear-bottom plates)
- Aluminum foil
- (Optional, but recommended) 0.45-micron filter
- (Optional) Black polyethylene bag(s) to temporarily store plate(s)
- Gen5 protocols listed below (as applicable for your reader model) and described in detail under [Gen5 Protocol Parameters](#) starting on page 88:
 - **Synergy H1_FI_T_MUB.prt** (filter-based system)
 - **Synergy H1_M_FI_T_MUB.prt** (monochromator-based system)

Test Solutions



Filter solutions to remove particulates that could cause erroneous readings. Do not allow dust to settle on the surface of the solution; use microplate covers or seals when not reading the plate.

Wrap the vial containing the MUB stock solution in foil to prevent exposure to light.

Discard any open, unused solutions after seven days.

1. Prepare the buffer (CBB) solution:
 - (Optional, but recommended) Using a 0.45-micron filter, filter 200 mL of deionized or distilled water.
 - Open and dissolve the contents of two CBB capsules (do not dissolve the outer gelatin capsule) into 200 mL of the water.
 - Stir the solution (preferably using a stir table) until the CBB is completely dissolved.
2. Prepare the MUB stock solution:
 - Add 1 mL of 100% methanol to the 10-mg vial of MUB.
 - Make sure all of the dye has completely dissolved and is well mixed. This yields a 10 mg/mL stock solution.
 - Wrap the solution in aluminum foil to prevent exposure to light.
3. Prepare the dilutions. Label each with "MUB" and the concentration.

Mix this MUB solution:	with:	to make:
0.5 mL of 10 mg/mL stock solution	4.5 mL of 100% methanol	1 mg/mL
0.88 mL of 1 mg/mL solution	4.12 mL of CBB	176 µg/mL
0.1 mL of 176 µg/mL solution	9.9 mL of CBB	1.76 µg/mL
0.5 mL of 1.76 µg/mL solution	4.5 mL of CBB	176 ng/mL
1 mL of 176 ng/mL solution	9 mL of CBB	17.6 ng/mL (100 nM)

Test Procedure

1. If you have not already done so, prepare the test solution; see instructions on page [131](#).

Refer to the pipette map on the next page for the remaining steps.

2. Perform the Sensitivity/Linearity tests using the Top optics of the filter-based fluorescence system:
 - Pipette the solutions into a new 96-well solid black or glass-bottom plate.
 - Create an experiment based on **Synergy H1_FI_T_MUB.prt** and read the plate.
3. If your reader is equipped with the monochromator-based fluorescence system, perform the Sensitivity/Linearity tests for that system:
 - Create an experiment based on **Synergy H1_M_FI_T_MUB.prt** and read the plate.
4. Save the experiments. Refer to the instructions starting on page [98](#) to perform calculations and determine pass/fail.
 - Troubleshooting tips are provided on page [101](#).
 - Test descriptions are provided on page [88](#).

Pipette Map

Using a single-channel pipette:

- Pipette **200 μ L** of the **17.6 ng/mL (100 nM) MUB** solution into well D7.
- Pipette 200 μ L of the buffer solution into wells C9, D9, and E9.

Using a multi-channel pipette with just four tips installed:

- Pipette **150 μ L** of the buffer into wells C2-F5. Discard the tips.
- Pipette 150 μ L of the **17.6 ng/mL (100 nM) MUB** solution into column 1.
- Pipette 150 μ L of the 17.6 ng/mL (100 nM) MUB solution into column 2. Mix the wells using the pipette. Do not discard the tips.
- Aspirate 150 μ L from column 2 and dispense into column 3. Mix the wells using the pipette. Do not discard the tips.
- Aspirate 150 μ L from column 3 and dispense into column 4. Mix the wells using the pipette. Do not discard the tips.
- Aspirate 150 μ L from column 4 and dispense into column 5. Mix the wells using the pipette. Do not discard the tips.
- Aspirate 150 μ L from column 5. Discard the solution and the tips.

	1	2	3	4	5	6	7	8	9	10	11	12
A												
B												
C	100 nM	50 nM	25 nM	12.5 nM	6.25 nM				BUF			
D	100 nM	50 nM	25 nM	12.5 nM	6.25 nM		MUB 100 nM		BUF			
E	100 nM	50 nM	25 nM	12.5 nM	6.25 nM				BUF			
F	100 nM	50 nM	25 nM	12.5 nM	6.25 nM							
G												
H												

Injection System Tests

Injection System Testing starting on page 102 describes the test methods, lists the Gen5 protocol parameters, explains how to analyze the test results, and provides troubleshooting tips in the event of test failure.

Materials

Manufacturer part numbers are subject to change.

- Absorbance reader with capability of reading at 405, 630, and 750 nm. The reader must have an accuracy specification of $\pm 1.0\% \pm 0.010$ OD or better and a repeatability specification of $\pm 1.0\% \pm 0.005$ OD or better.

The Synergy H1 may be used if it is equipped with Absorbance capabilities and has passed the Absorbance Plate Test or Absorbance Liquid Test 1.

- Microplate shaker (if the absorbance reader does not support shaking)
- Precision balance with capacity of 100 g minimum and readability of 0.001 g
- 50–200 μ L hand pipette and disposable tips
- Deionized water
- Supply bottles
- 250-mL beaker
- New 96-well, clear, flat-bottom microplates
- Green Test Dye Solution (BTI #7773003) undiluted, or one of the alternate test solutions provided on the next page
- 100-mL graduated cylinder and 10-mL pipettes (if not using BioTek's Green Test Dye Solution)
- Gen5 protocols listed below (as applicable for your reader model) and described in detail under *Gen5 Parameters* starting on page 102:

For models with Absorbance capabilities:

Synergy H1 **Disp 1 Test.prt**

Synergy H1 **Disp 2 Test.prt**

For models without Absorbance capabilities:

Synergy H1 **Disp 1 Test No Read.prt**

Synergy H1 **Disp 2 Test No Read.prt**

and, if you will use Gen5 with another BioTek absorbance-capable reader:

Synergy H1 **Disp Test Other Reader.prt**

Alternate Test Solutions

If you do not have BioTek's Green Test Dye Solution (PN 7773003), prepare a dye solution using one of the following methods:

80 μ L of test solution with 150 μ L of deionized water should read between 1.300 and 1.700 OD at 405/750 nm. The solutions should be at room temperature.

Using BioTek's Blue and Yellow Concentrate Dye Solutions:

Item	Quantity
Concentrate Blue Dye Solution (BTI #7773001, 125 mL)	4.0 mL
QC (Yellow) Solution (BTI #7120782, 125 mL)	5.0 mL
Deionized water	90.0 mL

Using FD&C Blue and Yellow Dye Powder:

Item	Quantity per Liter
FD&C Blue No. 1	0.200 grams
FD&C Yellow No. 5	0.092 grams
Tween 20	1.0 mL
Sodium Azide N_3Na	0.100 gram
Deionized water	make to 1 liter

Test Procedure for Models with Absorbance Capability

1. Prime both dispensers with 4000 μ L of deionized or distilled water.
2. Remove the inlet tubes from the supply bottles. Prime both dispensers with the Volume set to 2000 μ L. This prevents the water from diluting the dye.
3. Fill a beaker with at least 20 mL of the green dye solution. Prime both dispensers with 2000 μ L of the solution. When finished, remove the priming plate from the carrier.
4. Create an experiment based on the **Synergy H1 Disp 1 Test** protocol.
5. Place a new 96-well microplate on the balance and tare the balance.
6. Place the plate on the microplate carrier.



Running a dispense protocol with no plate on the carrier will contaminate the reading chamber with spilled fluid.

When each dispense step is finished, you will weigh the plate, record the weight, tare the balance with the plate on it, and then place the plate back on the carrier for the next step.

7. Initiate a plate read. Gen5 will prompt you to empty the tip priming trough.
8. When ready, proceed with the experiment. The sequence is as follows:
 - 80 μL /well is dispensed to columns 1–4.
 - When prompted, remove the plate and weigh it. Record the weight and tare the balance. Place the plate on the carrier.
 - 20 μL /well is dispensed to columns 5–8.
 - When prompted, remove the plate and weigh it. Record the weight and tare the balance. Place the plate on the carrier.
 - 5 μL /well is dispensed to columns 9–12.
 - When prompted, remove the plate and weigh it. Record the weight.
 - Manually pipette **150 μL** of deionized or distilled water into all 12 columns, on top of the green test dye solution.
 - Place the plate on the carrier for the shake and read steps.
9. When the experiment is complete, save the file with an identifying name.
10. Remove the plate from the carrier and set it aside.
11. Repeat the procedure using the **Synergy H1 Disp 2 Test** protocol and a new microplate.
12. When the tests are complete:
 - Prime both dispensers with at least 5000 μL of deionized water to flush out the dye solution.
 - Refer to the instructions on page [105](#) to perform calculations and determine pass/fail.
 - Test descriptions are provided on page [102](#).

Test Procedure for Models without Absorbance Capability

If you are not using a BioTek absorbance reader for this procedure, prepare your reader to perform two reads with the following characteristics:

	80 μ L Read	20 and 5 μ L Read
Primary Wavelength:	405 nm	630 nm
Reference Wavelength:	750 nm	750 nm
Plate Columns:	1–4	5–12

1. Prime both dispensers with 4000 μ L of deionized or distilled water.
2. Remove the inlet tubes from the supply bottles. Prime both dispensers with the Volume set to 2000 μ L. This prevents the water from diluting the dye.
3. Fill a beaker with at least 20 mL of the green dye solution. Prime both dispensers with 2000 μ L of the solution. When finished, remove the priming plate from the carrier.
4. Create an experiment based on the **Synergy H1 Disp 1 Test No Read** protocol.
5. Place a new 96-well microplate on the balance and tare the balance.
6. Place the plate on the microplate carrier.



Running a dispense protocol with no plate on the carrier will contaminate the reading chamber with spilled fluid.

When each dispense step is finished, you will weigh the plate, record the weight, tare the balance with the plate on it, and then place the plate back on the carrier for the next step.

7. Initiate a plate read. Gen5 will prompt you to empty the tip priming trough.
8. When ready, proceed with the experiment. The sequence is as follows:
 - 80 μ L/well is dispensed to columns 1–4.
 - When prompted, remove the plate and weigh it. Record the weight and tare the balance. Place the plate on the carrier.
 - 20 μ L/well is dispensed to columns 5–8.
 - When prompted, remove the plate and weigh it. Record the weight and tare the balance. Place the plate on the carrier.
 - 5 μ L/well is dispensed to columns 9–12.
 - When prompted, remove the plate and weigh it. Record the weight.
 - Manually pipette **150 μ L** of deionized or distilled water into all 12 columns, on top

of the green test dye solution.

- Carefully set the plate aside.
9. Close the experiment without saving it.

If you are not using a BioTek absorbance reader, read the plate using the parameters described in the table above. Perform the calculations and determine pass/fail according to the instructions on page [105](#).

10. If you are using a BioTek absorbance reader, configure Gen5 to communicate with the reader.
11. Create an experiment based on the **Other Reader** protocol and read the plate.
12. When the experiment is complete, save the file with an identifying name.
13. Remove the plate from the carrier and set it aside.
14. Repeat the procedure using the **Synergy H1 Disp 2 Test No Read** protocol and a new microplate.
15. When the tests are complete:
 - Prime both dispensers with at least 5000 μL of deionized water to flush out the dye solution.
 - Refer to the instructions on page [105](#) to perform calculations and determine pass/fail.
 - Test descriptions are provided on page [102](#).

Dispense Accuracy & Precision Tests — Dispenser # _____

80 μ L Dispense Delta ODs @405/750 nm				
	1	2	3	4
A				
B				
C				
D				
E				
F				
G				
H				

80 μ L weight: g

Expected weight: 2.5600 g

Accuracy % Error: %

Must be \leq 2.0% P F

Standard Deviation:

Mean:

%CV: %

Must be \leq 2.0% P F

Reader Model: _____

Reader S/N: _____

Reading Date: _____

Comments: _____

20 μ L Dispense Delta ODs @630/750 nm				
	5	6	7	8

20 μ L weight: g

Expected weight: 0.6400 g

Accuracy % Error: %

Must be \leq 5.0% P F

Standard Deviation:

Mean:

%CV: %

Must be \leq 7.0% P F

Reader Model: _____

Reader S/N: _____

Reading Date: _____

Comments: _____

5 μ L Dispense Delta ODs @630/750 nm				
	9	10	11	12
A				
B				
C				
D				
E				
F				
G				
H				

5 μ L weight: g

Expected weight: 0.1600 g

Accuracy % Error: %

Must be \leq 20.0% P F

Standard Deviation:

Mean:

%CV: %

Must be \leq 10.0% P F

Reader Model: _____

Reader S/N: _____

Reading Date: _____

Comments: _____

Reviewed/

Approved By: _____

Signature: _____

Dispense Accuracy & Precision Tests — Dispenser # _____

80 μ L Dispense Delta ODs @405/750 nm			
	1	2	3
A			4
B			
C			
D			
E			
F			
G			
H			

80 μ L weight: g

Expected weight: 2.5600 g

Accuracy % Error: %

Must be \leq 2.0% P F

Standard Deviation:

Mean:

%CV: %

Must be \leq 2.0% P F

Reader Model: _____

Reader S/N: _____

Reading Date: _____

Comments: _____

20 μ L Dispense Delta ODs @630/750 nm			
	5	6	7
			8

20 μ L weight: g

Expected weight: 0.6400 g

Accuracy % Error: %

Must be \leq 5.0% P F

Standard Deviation:

Mean:

%CV: %

Must be \leq 7.0% P F

Reader Model: _____

Reader S/N: _____

Reading Date: _____

Comments: _____

5 μ L Dispense Delta ODs @630/750 nm			
	9	10	11
			12
A			
B			
C			
D			
E			
F			
G			
H			

5 μ L weight: g

Expected weight: 0.1600 g

Accuracy % Error: %

Must be \leq 20.0% P F

Standard Deviation:

Mean:

%CV: %

Must be \leq 10.0% P F

Reader Model: _____

Reader S/N: _____

Reading Date: _____

Comments: _____

Reviewed/

Approved By: _____

Signature: _____

Specifications

This appendix contains BioTek's published specifications for the Synergy H1.

General Specifications	140
Absorbance Specifications	141
Fluorescence Specifications	142
Luminescence Specifications	143
Dispense/Read Specifications	144

General Specifications

Microplates

The Synergy H1 accommodates standard 6-, 12-, 24-, 48-, 96-, and 384-well microplates with 128 x 86 mm geometry, and the BioTek Take3 and Take3Trio Micro-Volume Plates.

Maximum Plate Height:

- Absorbance mode: plates up to 0.8" (20.30 mm) high
- Fluorescence, monochromator-based mode: plates up to 0.89" (22.6 mm) high
- Fluorescence (filter-based)/Luminescence modes: plates up to 0.89" (22.6 mm) high

Hardware and Environmental

Light Source	Xenon flash light source, not user-changeable 20W max. average power for Absorbance and monochromator-based Fluorescence (FI) 5W max. average power for TRF and filter-based Fluorescence (FI/FP)
Dimensions	Approximately 18.25" D x 14.75" W x 13" H (46.4 cm D x 37.5 cm W x 33 cm H) Note: For dimensions that include installation with a BioStack, refer to the <i>BioStack Operator's Manual</i>
Weight	For a model equipped with all available modules, excluding the power supply and dispense module, <55 lbs. (24.95 kg)
Environment	Operational temperature, 64° to 104°F (18° to 40°C)
Humidity	10% to 85% relative humidity (non-condensing)
Power Supply	24-volt external power supply compatible with 100–240 V~; ±10% @50–60 Hz
Power Consumption	250W maximum
Incubation	Maximum incubation temperature 45°C Uniformity ±0.5°C at 37°C, tested with Innovative Instruments, Inc. temperature test plate Top and bottom incubation controlled via software-adjustable gradient

Absorbance Specifications

Optics

Wavelength Range	230 to 999 nm
Wavelength Bandpass	<4 nm (230–285 nm), <8 nm (>285 nm)
Measurement Range	0.000 to 4.000 OD
Resolution	0.001 OD
Increment	1 nm
Wavelength Accuracy	±2 nm
Wavelength Precision	0.2 nm (standard deviation)
Wavelength Repeatability	± 0.2 nm

Performance

Specifications apply from 250–999 nm

Accuracy

Using certified neutral density glass

96-well plate, normal read speed

0–2 OD: ±1% ±0.010 OD, delay after plate movement=100 ms

2–2.5 OD: ±3% ±0.010 OD, delay after plate movement=100 ms

384-well plate, normal read speed

0–2 OD: ±2% ±0.010 OD, delay after plate movement=100 ms

2–2.5 OD: ±5% ±0.010 OD, delay after plate movement=100 ms

96-well and 384-well plate, sweep read speed

0–1 OD: ±1% ±0.010 OD

Linearity

By liquid dilution

96-well plate, normal read speed

0–2 OD: ±1% ±0.010 OD, delay after plate movement=100 ms

2–2.5 OD: ±3% ±0.010 OD, delay after plate movement=100 ms

384-well plate, normal read speed

0–2 OD: ±2% ±0.010 OD, delay after plate movement=100 ms

2–2.5 OD: ±5% ±0.010 OD, delay after plate movement=100 ms

96-well and 384-well plate, sweep read speed

0–1 OD: $\pm 1\% \pm 0.010$ OD

Repeatability

Using certified neutral density glass

Measured by one standard deviation (8 measurements/data point)

96-well and 384-well plate, normal read speed

0–2 OD: $\pm 1\% \pm 0.005$ OD, delay after plate movement=100 ms

2–2.5 OD: $\pm 3\% \pm 0.005$ OD, delay after plate movement=100 ms

96-well and 384-well plate, sweep read speed

0–1 OD: $\pm 2\% \pm 0.010$ OD

Fluorescence Specifications

The Synergy H1 measures fluorescence from the top and bottom with monochromators, and from the top with filters. The following sets of requirements apply to 96-well plates.

Monochromator-Based Fluorescence

Excitation Range	250–700 nm (with low-noise PMT) 250–900 nm (with red-shifted PMT)
Emission Range	250–700 nm (with low-noise PMT) 300–700 nm for emission scans (up to 900 nm with red-shifted PMT)
Bandpass	≤ 18 nm (Excitation and Emission)

Performance

Sodium Fluorescein in phosphate buffered saline (PBS)

DL ≤ 20 pM, top or bottom read

Excitation 485nm, Emission 528nm

Methylumbelliferone (MUB) in carbonate-bicarbonate buffer (CBB)

DL ≤ 0.16 ng/mL, top read

Excitation 360 nm, Emission 460 nm

Propidium Iodide (PI) in PBS

DL ≤ 62.5 ng/mL, bottom read

Excitation 485 nm, Emission 645 nm

Filter-Based Fluorescence

Fluorescence Intensity

Sodium Fluorescein in phosphate buffered saline (PBS)

DL \leq 10 pM, top read

Excitation 485/20 nm, Emission 528/20 nm, 510 nm mirror

Methylumbelliferone (MUB) in carbonate-bicarbonate buffer (CBB)

DL \leq 0.16 ng/mL, top read

Excitation 360/40 nm, Emission 460/40 nm, 400 nm mirror

Time-Resolved Fluorescence

Europium

DL \leq 250 fM, top read

Excitation 360/40 nm, Emission 620/40 nm, 400 nm mirror

Integration Time 20 to 16,000 μ s, Delay 0 to 16,000 μ s, Granularity 1- μ s steps

Fluorescence Polarization

Sodium Fluorescein

5 mP standard deviation at 1 nM sodium fluorescein

Excitation 485/20 nm, Emission 528/20 nm, 510 nm mirror

Excitation range 330–700 nm (UV-transparent polarizing filter)

Emission range 400–700 nm

Luminescence Specifications

\leq 75 amol/well DL ATP in a 96-well plate (low-noise PMT), 30 amol typical

\leq 500 amol/well DL ATP in a 96-well plate (red-shifted PMT)

Dispense/Read Specifications

Applies only to models equipped with injectors

Plate Type	Both injectors dispense to standard height 6-, 12-, 24-, 48-, 96-, and 384-well microplates
Detection Method	Absorbance, Fluorescence (FI, FP, TRF), Luminescence
Volume Range	5–1000 μL with a 5–20 μL tip prime
Accuracy	$\pm 1 \mu\text{L}$ or 2.0%, whichever is greater
Precision	$\leq 2.0\%$ for volumes of 50–200 μL $\leq 4.0\%$ for volumes of 25–49 μL $\leq 7.0\%$ for volumes of 10–24 μL $\leq 10.0\%$ for volumes of 5–9 μL

Error Codes

This appendix lists and describes Synergy H1 error codes that may appear in Gen5.

Overview	146
Error Codes	147

Overview

When a problem occurs during operation with the Synergy H1, an error code appears in Gen5. Error codes typically contain four characters, such as "4168," and in most cases are accompanied by descriptive text, such as "PMT overload error." With many errors, the instrument will beep repeatedly; press the carrier eject button to stop this alarm.

Some problems can be solved easily by the user, such as "2B0A: Priming plate not detected" (place a priming plate on the carrier). Some problems can be solved only by trained BioTek service personnel. This appendix lists the most common and easily resolved error codes that you may encounter.

Error codes beginning with "A" (e.g., A100) indicate conditions that require immediate attention. If this type of code appears, turn the instrument off and on. If the System Test does not conclude successfully, record the error code and contact BioTek's Technical Assistance Center.

If an error code appears in Gen5, you may want to run a System Test for diagnostic purposes. In Gen5, select **System > Diagnostics > Run System Test**.

Contact Info: BioTek Service/TAC

Use this appendix to diagnose problems and solve them if possible. If you need further assistance, contact BioTek's Technical Assistance Center.

Phone: 800-242-4685 (toll free in the U.S.) or 802-655-4740 (outside the U.S.)

Fax: 802-654-0638

E-Mail: tac@biotek.com

For errors that are displayed during operation of the Synergy H1 with the BioStack Microplate Stacker, refer to the *BioStack Operator's Manual*.

Error Codes

This table lists the most common and easily resolved error codes that you may encounter. If an error code appears in Gen5, look for it here. If you find the code, follow the suggestions provided for solving the problem. If you cannot find the code or if you are unable to solve the problem, please contact BioTek's Technical Assistance Center. The Gen5 Help system also provides troubleshooting tips.

Code	Description and possible remedy
2353	<p>Filter block not found on filter/mirror slider</p> <p>Verify that the filter block is correctly installed and that it matches the Gen5 optics library.</p>
2B0x	<p>Dispenser syringe 1 or 2 (respectively) did not home</p> <p>x=1-3</p> <p>Generally, this error indicates the syringe was not properly installed. Make sure the syringe's thumbscrews are properly threaded. (Refer to <i>Install the Dispense Module</i> starting on page 13 for instructions.) Restart the reader.</p>
2B0A	<p>Priming plate not detected</p> <p>Place the priming plate on the carrier.</p>
2B04	<p>Dispenser syringe 1 or 2 (respectively) failed position verify</p> <p>Generally, this error indicates the syringe was not properly installed. Make sure the syringe's thumbscrews are properly threaded. (Refer to <i>Install the Dispense Module</i> starting on page 13 for instructions.) Restart the reader.</p>
37x0/47x0 38x0/48x0 39xy/49xy	<p>Noise Test Errors</p> <p>Offset Test Errors</p> <p>Dark Range Errors</p> <p>x=0, 1; y=0-6</p> <p>This series of System Test errors may indicate too much light inside the chamber. Make sure the plate carrier door and the front hinged door are properly closed. For models with the dispense module, if the dispense tubes are not connected to the reader, re-install the light shield that shipped with the instrument (or cover the hole with black tape). Restart the reader.</p>

Code	Description and possible remedy
4xxx	<p>PMT overload well error at <well #xxx></p> <p>This error typically means that the fluid in a well has oversaturated the PMT (i.e., the well is too bright). Try lowering the gain in the read step.</p> <p>To identify the well:</p> <p>Wells are counted starting at A1, moving left-to-right, row-by-row. The row and column of the well can be extracted from the well number code by applying the following formula (example uses 8 x 12 geometry, 96-well plate):</p> <ol style="list-style-type: none"> 1. Convert the ASCII hex string to a decimal equivalent. Ex: "057" indicates 57 hex, yielding a well code of 87 decimal. 2. Row = (well code) / (columns in plate), rounded up to a whole number. Ex: 87/12 = 7.25, indicating row 8 (or H). 3. Column = (well code) - ((row-1) * (columns in plate)). Ex: 87 - ((8 - 1) * 12) = column 3. <p>NOTE: If this code is returned during an area scan, it indicates the scan point corresponding to the row/column equivalent in the currently defined scan map, NOT the actual well where the error occurred.</p>
4Exy	<p>Detector saturated (too much light). Relative Fluorescing Units (RFU) reached (99999).</p> <p>x=0, 1; y=0-6</p> <p>This error can indicate one of several scenarios. It is possibly due to incorrect chemistry, e.g., the fluorescence standards dispensed to the plate exceed expectations.</p> <p>Try lowering the gain/sensitivity in your Read step(s).</p> <p>For models with the dispense module, the internal chamber may require cleaning (contact BioTek TAC).</p> <p>If a 4E18 error is detected during monochromator-based fluorescence, the luminescence probe may be picking up stray light. Try installing a plug in the filter cube. Restart the reader.</p>

Code	Description and possible remedy
4Fxy	<p>Fluorescence signal out of range x=0, 1; y=0-6</p> <p>Verify that the Gen5 Fluor/Lum wavelengths table matches the actual filter installed in the filter cube. Verify that there is no filter wavelength overlap between the emission/excitation positions.</p> <p>Verify that the microplate door is fully closing, and the instrument cover is properly installed and sealed.</p> <p>Try lowering the Gain in your Read step(s).</p> <p>The reading chamber may be contaminated by a spill that is fluorescing; see the Preventive Maintenance chapter.</p>
5003/5103	<p>Filter cube did not home</p> <p>Generally, this error indicates the filter cube is not seated properly in the reader. Remove it, ensure each filter or plug is properly positioned and reinstall it securely. Restart the reader.</p>
5403	<p>Filter cube failed positional verify</p> <p>Generally, this error indicates the filter cube is not seated properly in the reader. Remove it, ensure each filter or plug is properly positioned and reinstall it securely. Restart the reader.</p>
55xy	<p><Motor> not homed successfully</p> <p>xy=axis</p> <p>This error indicates that an axis failed a previous verify function and now needs to be homed. Verify that the shipping brackets have been removed. Check for any obstructions that may prevent the carrier, syringes, or filter cube from moving normally. Restart the reader.</p>

Code	Description and possible remedy
570x	<p>Axis obstruction error</p> <p>This error indicates that a moving part is being obstructed. Verify that:</p> <ul style="list-style-type: none"> the tip priming trough, microplate, plate lid, or other object has not become dislodged in the reading chamber the Plate Type selection in the Gen5 procedure is correct for the plate in use, and the Plate Height measurement is correct the filter cube is correctly installed nothing is preventing the dispenser syringes from moving <p>For some plate type and read probe combinations, it might not be possible to define the entire area scan matrix offered by Gen5 for some perimeter wells, due to the physical limitations of carrier travel. Redefine the area scan to include a smaller matrix or select wells in a different row or column.</p>
5A0x	<p>Plate carrier hit obstruction and lost steps</p> <p>x=0, 1</p> <p>Verify that the microplate is properly and securely seated in the carrier, and nothing is obstructing carrier movement inside the reading chamber.</p> <p>Verify that the Plate Type defined in the Gen5 Protocol matches the plate you are using.</p> <p>This error can also occur if the plate type is correct but the lid was left on the plate. If you wish to read the plate with a lid on it, create a new plate type in Gen5 and add the height of the lid to the Plate Height. Note: Gen5 version 2.01 introduces a separate "Plate Lid adds" parameter.</p>
5B00	<p>Plate carrier needs to be ejected from the reading chamber</p> <p>The carrier is inside the read chamber and the probe needs to move down for the requested operation. Press the carrier eject button. (This may occur if read was aborted and "home all axis" not performed.)</p> <p>This error can also occur if the carrier is inside and the newly-defined plate height is different from the most-recently specified plate height. To resolve this error, eject the carrier prior to running the experiment.</p>

Instrument Dimensions for Robotic Interface

This appendix shows the location of the microplate carrier in reference to the exterior surfaces of the Synergy H1 and the mounting holes on the bottom. Use the illustrations to facilitate system setup with a robotic instrument, such as the BioStack Microplate Stacker. Dimensions are in inches.

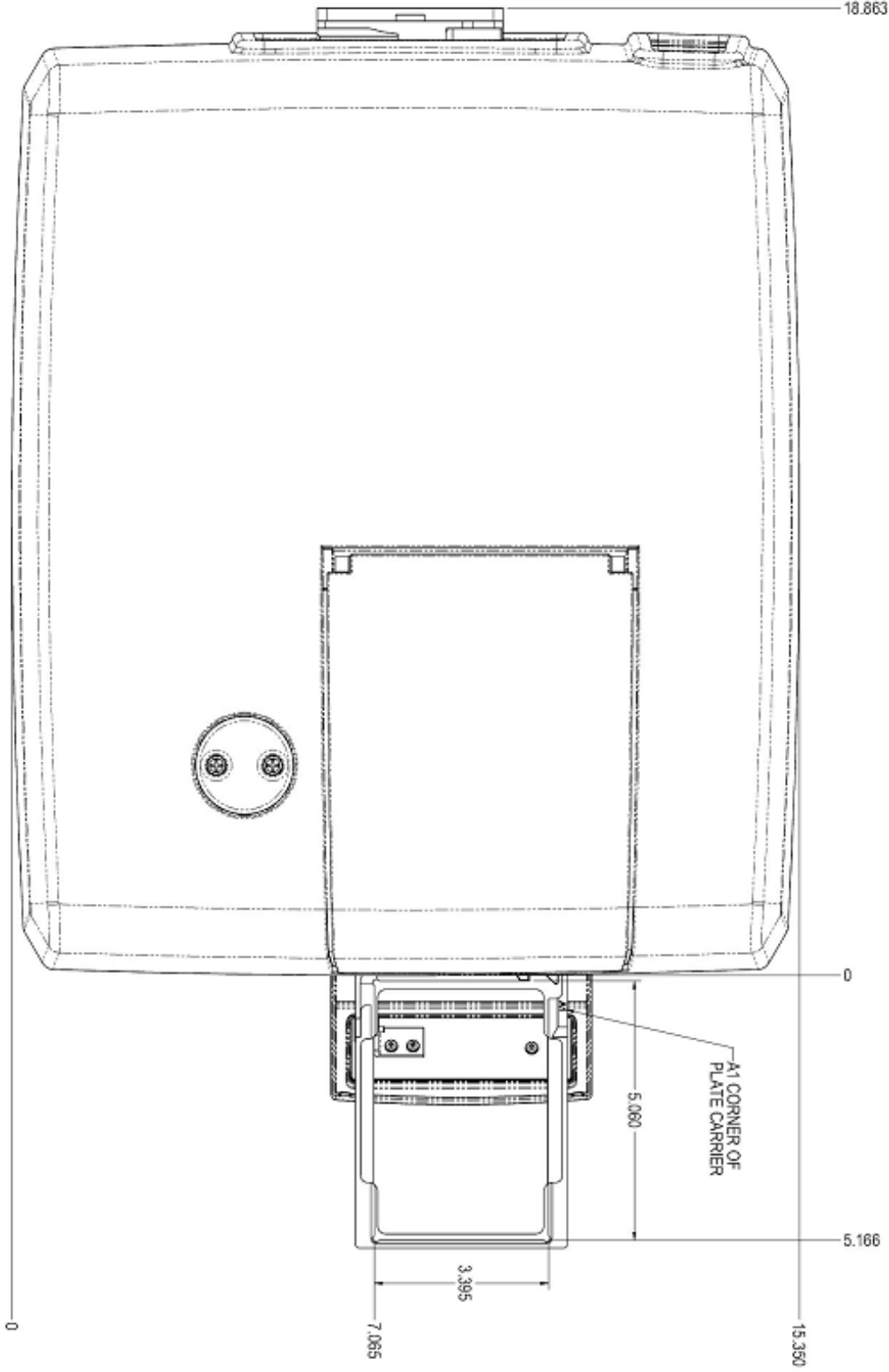

Figure C-1: Top view

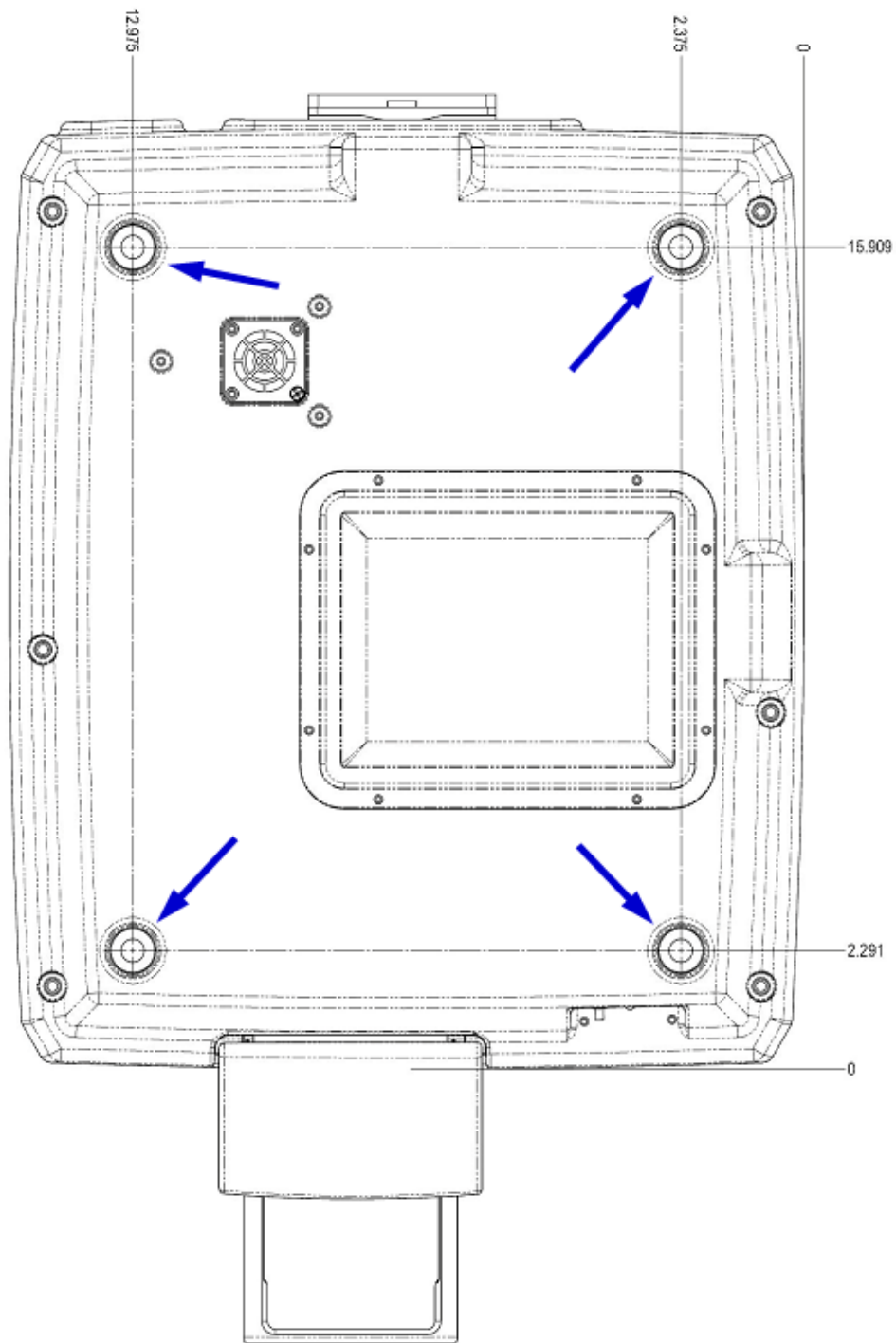

Figure C-2: Bottom view

The arrows point to special mounting holes for alignment caps for operation with the BioStack; note that the model shown is not gas-ready.

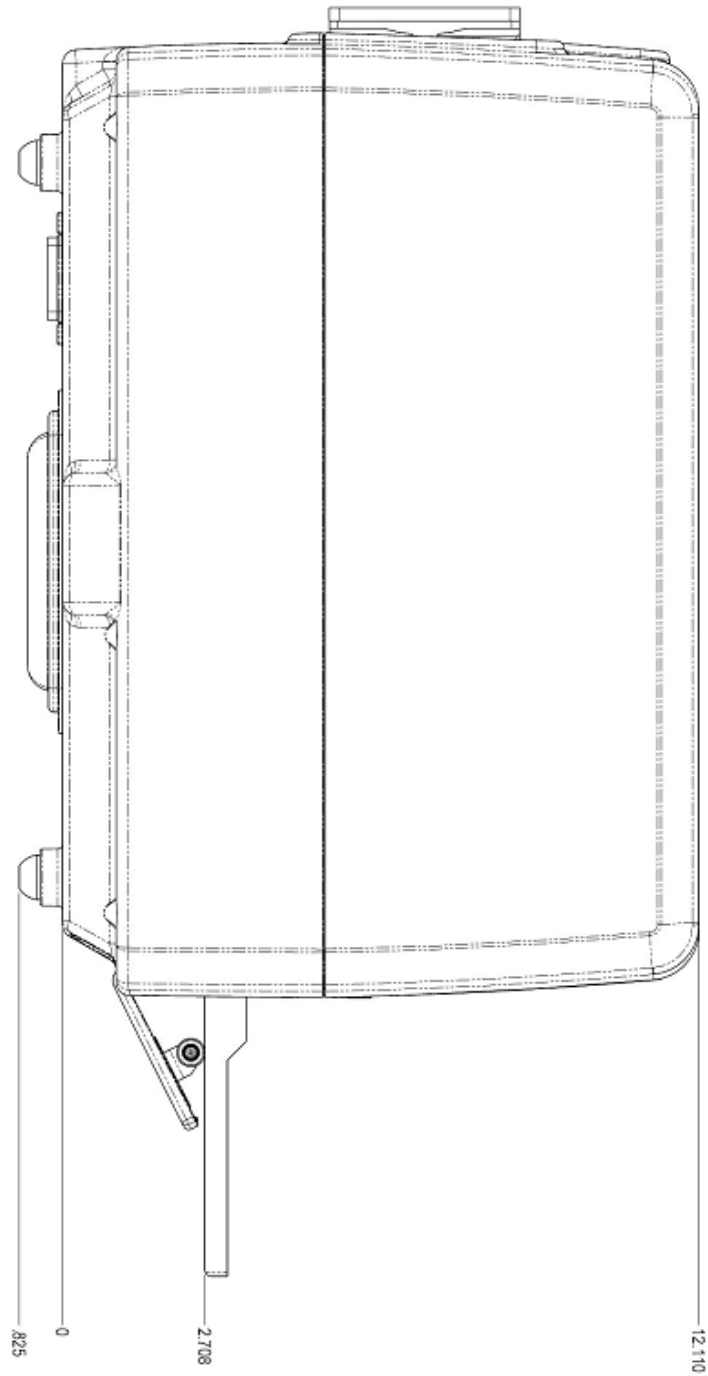

Figure C-3: Left side view

BioStack users: Special alignment hardware is included in the BioStack's alignment kit for correct positioning with the Synergy H1. Refer to the **Installation** chapter in the *BioStack Operator's Manual* for instructions.

Sample Reports

This appendix contains sample System Test and Absorbance Plate Test reports for the Synergy H1.

Gen5 System Test Report

Reader: Synergy H1 (Serial Number: 1506126)
 Basecode: P/N 8040200 (v2.00)
 Gen5 Version: 2.07.17
 Date and Time: 6/12/2015 2:28:12 PM
 User: 4205
 Company: BioTek
 Comments:

Test Results

SYSTEM TEST PASS

Operator ID: _____

Notes: _____

SYSTEM SELF TEST

8040200	Version 2.00	1506126	S1	S2	S3
			1110	0100	
			DMF		
Voltage Reference Test	Min	Low	High	Max	
Mono System Flash	1412	1750	2318	3098	
Filter System Flash	2338	2922	3507		
Switched 24V Power	1886				

ABSORBANCE

Optics Test	Ref	Meas	Gain	Resets
#1:230			1.91	2
Light	13389	39922		
Dark	10613	10655		
Delta	2776	29267		
#2:285			2.91	8
Light	13064	39639		
Dark	10647	10679		
Delta	2417	28960		
#3:405			1.62	8
Light	12886	39571		
Dark	10621	10641		
Delta	2265	28930		
#4:630			1.65	8
Light	12611	39827		
Dark	10622	10642		
Delta	1989	29185		
#5:800			2.12	4
Light	12502	39891		
Dark	10626	10657		
Delta	1876	29234		

#6:999			1.88	2
Light	12410	39607		
Dark	10613	10653		
Delta	1797	28954		
Noise Test	Ref	Meas		
Gain 1.00				
Max	10592	10629		
Min	10591	10628		
Delta	1	1		

FLUORESCENCE/LUMINESCENCE

Monochromator PCB

Bias current offset	-0.8 counts	PASS
Offset voltage	1683 counts	PASS
750V measurement	28.4 counts	PASS
750V noise	4 counts	
750V offset	1684 counts	
Reset offset	1724 counts	
Reference bias	-2.3 counts	PASS
Reference offset	10605 counts	PASS
Reference noise	0.2 counts	PASS

Filter PCB

Bias current offset	-0.4 counts	PASS
Offset voltage	1701 counts	PASS
750V measurement	53.8 counts	PASS
750V noise	7 counts	
750V offset	1704 counts	
Reset offset	1732 counts	
Reference bias	3.6 counts	PASS
Reference offset	10614 counts	PASS
Reference noise	0.2 counts	PASS

Filter Fluorescence

Top Probe

Reference	400V	500V	600V
Gain	2.03	1.18	1.00
Light	11737	11716	12020
Dark	10641	10619	10614
Delta	1096	1097	1406

Mono Fluorescence - Optics Test

Top Probe

	662V	
Sensitivity:37	Ref	Meas
#1:300		
Light	17882	7533
Dark	10644	1683
Delta	7238	5850
Max	7384	5891
Min	7100	5777
StdDev	79	30

#2:485

Light	35740	22078
Dark	10644	1679
Delta	25096	20399

Max	25471	20560
Min	24794	20239
StdDev	225	99
Bottom Probe	662V	
Sensitivity:45	Ref	Meas
#1:300		
Light	17888	5495
Dark	10645	1683
Delta	7243	3812
Max	7389	3885
Min	7167	3756
StdDev	69	39
#2:485		
Light	35657	22859
Dark	10645	1681
Delta	25012	21178
Max	25211	21448
Min	24799	20920
StdDev	137	146

CALIBRATION

Carrier - Top Mono Fluorescence

Upper Left	x= -116	y= 8616
Lower Left	x= -116	y= 2404
Lower Right	x= 9652	y= 2396
Upper Right	x= 9652	y= 8612
Delta 1	-116 - -116=	+0
Delta 2	9652 - 9652=	+0
Delta 3	8612 - 8616=	-4
Delta 4	2396 - 2404=	-8

Carrier - Bottom Mono Fluorescence

Upper Left	x= 1856	y=10460
Lower Left	x= 1856	y= 4252
Lower Right	x=11624	y= 4248
Upper Right	x=11624	y=10464
Delta 1	1856 - 1856=	+0
Delta 2	11624 -11624=	+0
Delta 3	10464 -10460=	+4
Delta 4	4248 - 4252=	-4

Carrier - Absorbance

Upper Left	x= 1888	y= 8580
Lower Left	x= 1888	y= 2372
Lower Right	x=11652	y= 2368
Upper Right	x=11652	y= 8580
Delta 1	1888 - 1888=	+0
Delta 2	11652 -11652=	+0
Delta 3	8580 - 8580=	+0
Delta 4	2368 - 2372=	-4

Carrier - Top Luminescence

Upper Left	x= -856	y= 6612
Lower Left	x= -852	y= 400
Lower Right	x= 8916	y= 404

Upper Right x= 8912 y= 6612
Delta 1 -856 - -852= -4
Delta 2 8912 - 8916= -4
Delta 3 6612 - 6612= +0
Delta 4 404 - 400= +4

Carrier - Top Filter Fluorescence

Upper Left x=-3672 y= 6612
Lower Left x=-3668 y= 404
Lower Right x= 6096 y= 396
Upper Right x= 6096 y= 6612
Delta 1 -3672 --3668= -4
Delta 2 6096 - 6096= +0
Delta 3 6612 - 6612= +0
Delta 4 396 - 404= -8

Carrier - Injectors

Upper Left x= 2196 y= 6616
Lower Left x= 2196 y= 404
Lower Right x=11964 y= 396
Upper Right x=11964 y= 6612
Delta 1 2196 - 2196= +0
Delta 2 11964 -11964= +0
Delta 3 6612 - 6616= -4
Delta 4 396 - 404= -8

Carrier - Test Sensors

Middle Sensor x=20628
Tested 20636
Delta +8

Probe Height 25.99 mm

Filter/Mirror Slider 4424

Mono Probe Changer 3072

Backlash 44

Excitation Monochromator

Absorbance B=-0.00241697 C=+0.50917959
305LP Edge +779.17
Tested +780.18

Emission Monochromator

Top Fluorescence B=-0.00231930 C=+1.28592360
Bottom Fluorescence B=-0.00029174 C=-0.21822651

INCUBATION

Temperature Setpoint: 0.0 Current Average: 26.9 A/D Test: PASS

Zone 1: 27.1	Min: 27.1	Max: 27.2	Range: PASS	Thermistor: PASS
Zone 2: 27.0	Min: 27.0	Max: 27.1	Range: PASS	Thermistor: PASS
Zone 3: 26.8	Min: 26.8	Max: 26.8	Range: PASS	Thermistor: PASS
Zone 4: 26.7	Min: 26.6	Max: 26.7	Range: PASS	Thermistor: PASS

0000

Dispenser 1: 005.2,010.5,020.5,040.4,080.4,200.4

Dispenser 2: 005.2,010.2,020.2,040.1,079.9,199.8

Filter Cube: Default

Filter Set 1: Blue Ex: 360/40 Mirror: Top 400 nm Em: 460/40

Filter Set 2: Green Ex: 485/20 Mirror: Top 510 nm Em: 528/20

Reviewed/Approved By: _____

Date: _____

Repeatability Results

Wells	C1	E2	G3	H6	F5	D4
Read 1	0.134	0.443	0.869	1.271	1.238	1.586
Min Limit	0.128	0.433	0.855	1.253	1.221	1.565
Max Limit	0.140	0.452	0.882	1.289	1.256	1.607
Read 2	0.134	0.443	0.869	1.271	1.238	1.586
Result	PASS	PASS	PASS	PASS	PASS	PASS

Reviewed/Approved By: _____

Date: _____